

**Title:** Designing liposomal adjuvants for the next generation of vaccines.

**Authors:** Yvonne Perrie\*, Fraser Crofts, Andrew Devitt, Helen R Griffiths, Elisabeth Kastner and Vinod Nadella.

Aston Pharmacy School, School of Life and Health Sciences, Aston University, Birmingham, UK, B4 7ET.

\*Correspondence: Professor Yvonne Perrie  
Aston Pharmacy School  
School of Life and Health Sciences  
Aston University, Birmingham, UK. B4 7ET.  
Tel: +44 (0) 121 204 3991  
Fax: +44 (0) 121 359 0733  
E-mail: [y.perrie@aston.ac.uk](mailto:y.perrie@aston.ac.uk)

Keywords: Liposomes, vaccines, adjuvants, antigens, delivery systems, microfluidics, QbD, MVA.

**Abstract**

Liposomes not only offer the ability to enhance drug delivery, but can effectively act as vaccine delivery systems and adjuvants. Their flexibility in size, charge, bilayer rigidity and composition allows for targeted antigen delivery via a range of administration routes. In the development of liposomal adjuvants, the type of immune response promoted has been linked to their physico-chemical characteristics, with the size and charge of the liposomal particles impacting on liposome biodistribution, exposure in the lymph nodes and recruitment of the innate immune system. The addition of immunostimulatory agents can further potentiate their immunogenic properties. Here, we outline the attributes that should be considered in the design and manufacture of liposomal adjuvants for the delivery of sub-unit and nucleic acid based vaccines.

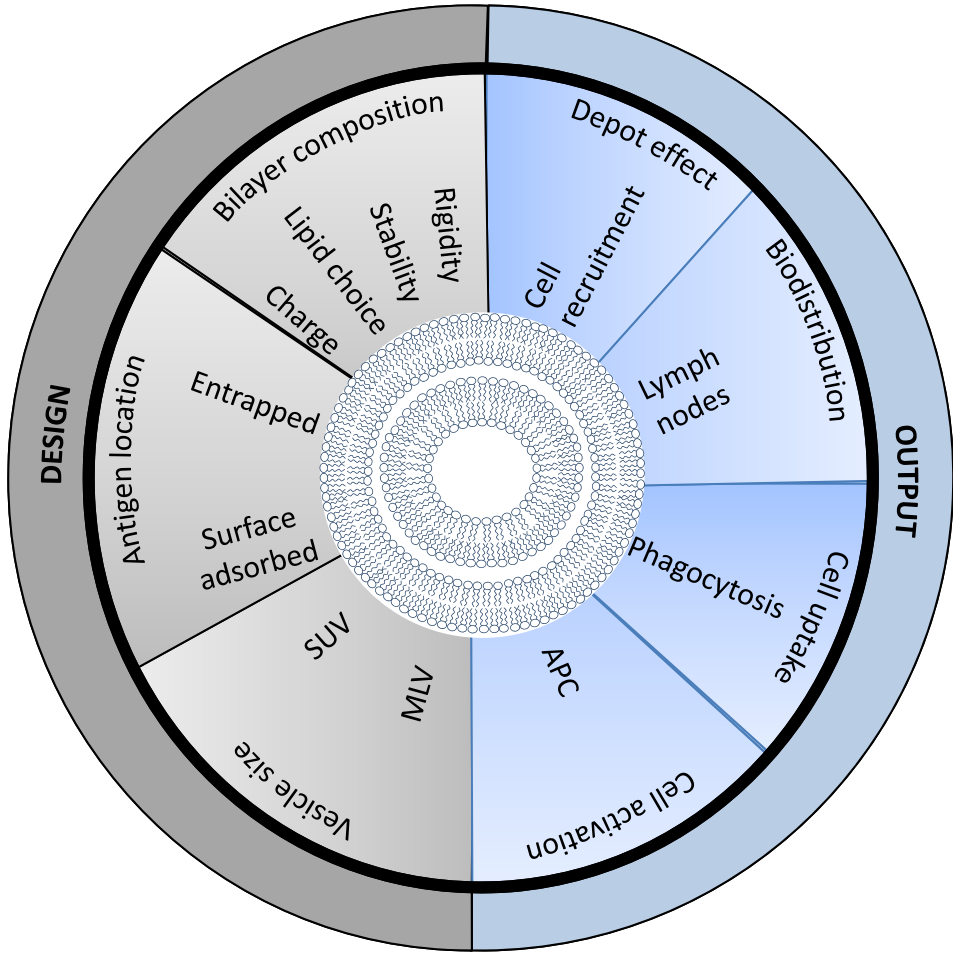

## Table of Contents

1. Developing new vaccines .....	4
1.1. Liposomes as vaccine adjuvants. ....	4
2. Liposomal adjuvants – how can we use our knowledge of their mechanisms of action to drive their development? .....	5
2.1 Physico-chemical attributes that can impact of liposomal adjuvant action.....	5
2.2 Designing liposomes with enhanced immunostimulatory activity.....	8
3. Using liposomes to deliver nucleic acid-based vaccines.....	11
4. New methods for testing liposomal vaccine adjuvants .....	13
5. Manufacturing hurdles faced in the progression of liposomal adjuvants to the market.....	16
5.1 Manufacture of liposomal adjuvants using microfluidics .....	17
5.2 Implementing quality in liposomal adjuvant manufacturing by Quality by Design.....	19
6. Conclusions .....	20
7. Acknowledgements.....	21

## **1. Developing new vaccines**

Vaccines remain the most cost-effective way to prevent infectious diseases. Due to the development of effective vaccines we have seen the global eradication of smallpox (declared in 1980) and more recently Rinderpest (also known as cattle plague, an infectious viral disease of cattle, declared in 2011). Vaccination has also promoted the dramatic reduction in the instances of polio, diphtheria, tetanus, pertussis, measles, mumps and rubella. Despite this success story, infectious diseases cause approximately 25 % of world mortality [1]. In the development of new vaccines, we have a range of vector options available. Live attenuated, can offer lifelong immunity, and strong humoral and cell mediated protection. However, these vaccines are not appropriate for immunocompromised people and there is a risk that live attenuated vaccines can revert to their virulent form. In contrast, inactivated vaccines offer improved safety profiles but cannot provide effective long-term protection from pathogens [2] due to the destruction of the pathogen replication and transformation mechanisms [3, 4], often resulting in the need for high and multiple dose treatments. Similarly, sub-unit vaccines have a good safety profile but lower potency. To address this issue, adjuvants can be employed to enhance and/or prolong immune responses. Whilst their mechanism of action is yet to be fully elucidated, vaccine adjuvants can function through a range of mechanisms including formation of a depot, enhancing antigen delivery, uptake and presentation to appropriate antigen presenting cells, and induction of stimulatory cytokines and chemokines. There are a range of adjuvant systems already in use including aluminium based adjuvants which have been used in vaccines since the 1930s. More recently new adjuvants such Novartis's MF59 (an oil-in-water emulsion consisting of squalene, Tween 80 and Span 85), GSK's ASO3 (a squalene, Tween 90 and  $\alpha$ -Tocopherol oil-in-water emulsion) and ASO4 (Aluminium hydroxide and monophosphoryl lipid A), and the Virosomes system of Bernal Biotech have been used in licensed vaccines [5]. However despite these advances, to tackle newly emerging diseases and re-emerging diseases, there is a continued need for new adjuvants.

### **1.1. Liposomes as vaccine adjuvants.**

Particulate drug delivery systems offer the potential to act as adjuvants. They offer the ability to incorporate sub-unit antigens within pathogen-sized particles that protect antigens from degradation and facilitate delivery to antigen presenting cells. Of the particulate drug delivery systems available, liposomes were the first system described to offer adjuvant action with their immunological role and adjuvant properties being identified by Allison and Gregoriadis (1974) [6]. In these studies, it was noted that negatively charged liposomes incorporating dicetyl phosphate were able to potentiate immune responses against diphtheria toxoid. Since this seminal work by Allison and Gregoriadis into the use of liposomes as adjuvants, all manner of vesicle size, charge and bilayer design have been

investigated for their efficacy. Yet, liposomes are not the only bilayer vesicles offering adjuvant properties. Whilst phosphatidylcholines are generally the most common lipids employed, a wide range of lipids have been investigated to prepare vesicles such as niosomes (e.g. [7]), virosomes (e.g. [8]) and bilosomes (e.g. [9]). These variations on a theme can offer different attributes. For example, incorporation of bile salts into the bilayer of vesicles (to form bilosomes) can improve oral delivery of vaccines by preventing natural stomach digestive enzymes from disrupting the vesicles. Alternatively, virosomes incorporating virus derived proteins promote cell fusion and delivery of viral antigens and have been successfully licenced as adjuvants in vaccines against Hepatitis A and Influenza [10]. However despite this, the development and application of liposomes as adjuvants is currently limited to two vaccine systems based on virosomes - Inflexal (against influenza) and Epaxal (against hepatitis A).

## **2. Liposomal adjuvants – how can we use our knowledge of their mechanisms of action to drive their development?**

By limiting microbial growth, the innate immune system is a powerful system that is essential in the early stages of defence against immune challenge. However, it also drives the development of adaptive immune responses that are essential to enabling the body to clear any given pathogen. The innate immune system comprises many factors, both cellular (e.g. dendritic cells, macrophages, mast cells and neutrophils) and soluble (i.e. humoral) factors that can coordinate cellular responses. It is the integration with the adaptive immune system that underlies the functional significance of the innate immune system.

When developing novel vaccines, the ability to stimulate the innate immune responses needs to be considered. For live vaccines, this happens naturally with growth of any live attenuated organisms. However where no live, active infection occurs, the immune system requires additional stimulation in the form of adjuvants. Liposomal adjuvants have been known to function by offering both protection and enhanced delivery of the vaccine antigen and depending on their design they can promote antigen presentation and/or facilitate the formation of a depot resulting in attraction of antigen presenting cells that engulf antigen and become activated (Fig 1).

### **2.1 Physico-chemical attributes that can impact of liposomal adjuvant action.**

To improve antigen delivery to antigen presenting cells there are a wide variety of lipids available ranging from natural or synthetic, cationic or anionic, unsaturated or saturated, long or short chain, single or double chain; and these can all be used in a range of combinations. The choice of lipid used

in the formulation and the manufacturing method can all influence the physico-chemical attributes of the liposomes formed. This in turn influences their adjuvant action; it is recognised that cellular uptake, antigen processing and the presentation by antigen presenting cells are partially dictated by these particle characteristics [11]. There are a range of physico-chemical factors that should be considered in the design of liposomes as adjuvants. For example, the choice of lipid used can impact on the fluidity of the liposomes bilayers. The location and degree of hydrocarbon chain saturation, in addition to hydrocarbon chain length, all affect the strength of the van de Waals forces that hold adjacent chains together within the bilayer. Hence longer chain length lipids tend to form rigid ordered bilayer structures whilst those with shorter tails will become fluid and disorganized. To consider the impact of bilayer fluidity on liposomal adjuvant activity, Maxumdar and Ali [12], investigated the protective efficacy of liposome encapsulated *Leishmania Donovanii* antigens. They tested three different liposomes formulations prepared from distearyl derivative of 1- $\alpha$ -phosphatidyl choline (DSPC) (with a liquid crystalline transition temperature of 54°C), dipalmitoyl phosphatidyl choline (DPPC) (transition temperature of 41°C) and dimyristoyl (DMPC) (Tc 23°C) for their ability to entrap *Leishmania donovani* membrane antigens and to potentiate strong antigen-specific antibody responses [12]. The authors demonstrated improved adjuvant activity with DSPC liposomes (95% protection in mouse challenge studies), with almost no protection in mice immunised with antigen in DPPC or DMPC liposomes. This effect of changing membrane fluidity may affect the adjuvant activity through both cellular interactions and biodistribution. Within our studies we also demonstrated that rigid liposomes prepared using dimethyldioctadecylammonium (DDA) bromide lipid promoted stronger immune responses than more fluid liposomes prepared using the unsaturated analog dimethyldioleoylammonium bromide (DODA), which contained one unsaturated C=C bond in each of the lipophilic acyl chains [13]. In biodistribution studies, the rigid DDA-based liposomes were shown to promote higher levels of antigen at the injection site, resulting in a continuous attraction of antigen-presenting cells that expressed elevated levels of the co-stimulatory molecules CD40 and CD86 [13]. Indeed the rigid, DDA-liposomes induced 100-fold higher Th1 responses than the fluid DODA liposome counterparts.

Inclusion of cholesterol within liposomes is also known to influence bilayer fluidity and is commonly incorporated within liposome formulations for drug delivery, as it can enhance liposome bilayer stability by inserting in the lipid bilayer and stabilise the system [14]. However, in terms of the impact of liposomal adjuvant action the effect of cholesterol is unclear; whilst some studies have shown improvements in the immune response [15, 16], others have noted reduced responses [17, 18].

Vesicle size has also been shown to influence liposomal adjuvant efficacy and studies have shown that vesicle size can influence the development of the immune responses towards a Th1 or Th2 cytokine profile via a range of routes [19-23]. For example, studies have described enhanced Th2 responses after administration of smaller particles whilst larger particles promote IFN- $\gamma$  and typical Th1 responses [19, 20]. This may be a result of differences in particle trafficking to local lymph nodes and uptake by antigen presenting cells, with larger vesicles (650 nm) showing improved antigen tracking, processing and antigen presentation compared to smaller (155 nm) vesicles [21]. Similarly, uptake of particulates by DC was only observed at the injection site when large (0.5 – 2  $\mu$ m) particles were used rather than small (20 – 200 nm) particles [22]. In recent studies, we have also shown that the size of cationic liposomal adjuvants is a controlling factor for pharmacokinetics and biodistribution, which dictates the resulting immune response [24]. Differences in the draining of liposomes of different sizes was observed *in vivo* using small liposomes below 200 nm, medium sized vesicles between 500 – 600 nm and large multilamellar vesicles in the micrometer range. In these studies, significantly higher amounts of the 200 nm liposomes were noted at the popliteal lymph node, 6 hours after injection. However, there did not result in differences in cellular phagocytosis, as macrophage uptake of the liposomes was not size-dependent [24]. In terms of immune responses, vesicle size did not impact on antibody production, but a positive correlation of size with cell proliferation rates and an inverse correlation on IL-10 production was noted.

Antigen location and liposomal charge have also been shown to influence liposomal adjuvant activity. Early work by Gall and colleagues identified a range of cationic lipids capable of disrupting cell monolayers, causing haemolysis of sheep red blood cells and damage to tissue at the injection site [25]. The lipids identified have long (> 12) carbon chain lengths and cationic in nature. In particular, lipids with a quaternary ammonium head group showed high levels of activity. Whilst a cationic surface charge can present issues when administered intravenously, due to aggregation and rapid clearance by the mononuclear phagocyte system, when administered via other routes this is less of a concern. Indeed, when adopted within a liposomal adjuvant formulation, their cationic nature can promote sub-unit antigen binding to the liposome surface and stimulate interaction with the anionic surface of APC and have been shown to promote strong adaptive immune responses [26] compared to neutral formulations that tend to promote a humoral based response [27]. Furthermore, the aggregation of cationic liposomes after injection may also be part of their success as vaccine adjuvants given that their aggregation upon injection will result in a depot-effect whereby liposome and consequently antigen are retained in the tissue for an extended period of time [28]. However, anionic lipids may also offer advantages to the formulation of liposomal adjuvants. Anionic lipids are



known to be recognised by macrophages with a number of specific phosphatidylserine (PS) receptors being identified. Much of this work arises from the study of apoptotic cell clearance where PS is exposed on the outer leaflet of the plasma membrane as cells die. Early work indicated that artificial PS-containing liposomes may mediate anti-inflammatory/tolerogenic effects in APC and consequently PS may not induce the desired downstream APC response. Anionic surface charges for oral vaccination may also offer advantages given the anionic nature of the mucosal barrier which can interact with cationic moieties [29, 30] and work by Shakweh et al suggests that negatively charged or neutral particles in mice have a greater affinity for the Peyer's patches than positively charged particles [31].

Overall, it is clear that the physicochemical characteristics of liposomal adjuvant, as summarised in Figure 2, can modulate adjuvant efficacy. However, the ideal parameters required for an optimised liposomal adjuvant are yet to be confirmed. This is not surprising given the vast array of lipid combinations/liposome constructs that can be considered, and that the impact of these characteristics will be multi-factorial. Furthermore, effective adjuvants must not only promote antigen delivery, they must also promote cellular interactions and activation of APC. To achieve this, one must consider more than the liposome physico-chemical characteristics.

## 2.2 Designing liposomes with enhanced immunostimulatory activity

To move beyond physical attributes and develop stronger liposomal adjuvants, a clear understanding of the different stages that occur in the development of a protective innate immune response is required. An essential component of the innate immune system is pattern recognition via pattern recognition receptors (PRR) [32]. Self/non-self recognition is a central decision point in immunology. Why do we respond to some antigens and not others? From an adjuvant/vaccine development perspective, an answer to this question is paramount. The old-fashioned model of self/non-self discrimination has long been queried and many developments to the theories of immune recognition have occurred [33]. However a most important stride in our understanding came from the work of Charles Janeway who proposed that the innate immune system discriminated 'non-self' ('infectious non-self') from 'self' ('non-infectious self') at the point of recognition [34]. That is to say, infectious agents were foreign and exposed patterns are evolutionarily conserved (so called pathogen-associated molecular patterns or PAMPs) and such PAMPs were proposed to be recognised by pattern recognition receptors (PRR). The net result of this work is to highlight the importance of PRR ligation to activate cells of the innate immune system [35]. Specifically this refers to the need to activate quiescent antigen presenting cells (APC e.g. dendritic cells, macrophages and B cells). Dendritic cells are perhaps the most important APC as they activate naïve T lymphocytes and thus are a key cellular

link between the innate and adaptive immune systems. DC are highly phagocytic cells that eat both self and non-self material but direct different responses. Uptake of self (e.g. apoptotic cells) will drive tolerance [36, 37] but whilst this can also occur through the use of PRR [38] [39], it is the ability of pathogens via PRR ligation to *signal* to activate the DC that enables a strong immune response to follow. Crucially this will use the Toll-like receptors and NOD-like receptors type PRR. Naturally it is essential that an adjuvant/vaccine formulation acts to drive strong immunogenic responses rather than tolerance and synthetic PRR agonists have been predicted to be the most efficacious [40]. A good example of the drive for PRR ligation is the use of monophosphoryl lipid A (MPL), a modification of the endotoxic lipid A of LPS (a TLR agonist). MPL drives PRR signalling and immune cell activation but is significantly less toxic than LPS. As such MPL was the first licensed TLR agonist to be used in a vaccine formulation (Fendrix (hepatitis B) and Cervarix (human papilloma virus) and has also been included in liposomal formulations e.g. in the GSK formulation AS01 where 3'-O-desacyl-4'-monophosphoryl lipid A is combined with a liquid suspension of liposomes is association with a further immunostimulatory component (QS21). Liposomes are particularly well suited to the incorporation of immunostimulatory agents that are able to bind to PRRs, for example bacterial modelled glycolipids such as MPL and TDB. Inclusion of such substances in adjuvant formulations can improve their immunostimulatory abilities in a synergistic manner [41]. Table 1 lists some PAMP-containing liposomal formulations and their respective PRRs currently being investigated.

By understanding this basic immune cell biology, we can better design adjuvant formulations. Such developments may target different PRR and perhaps multiple PRR to ensure strong and appropriate immune cell activation. Importantly, our insight to the cell biology of immune cell activation permits us to design a series of assays to pre-screen formulations for likelihood of success in vivo. Clearly, an adjuvant that fails to stimulate maturation of quiescent DC or activation of macrophages in vitro is not likely to be successful in vivo. This represents a simple concept but one that may help drive high-throughput screening of libraries of novel formulations.

At a simple level, one could consider that the necessary steps that are required for a liposomal adjuvant to stimulate a protective immune response via activation of APC are:

1. Attraction of APC: DC and macrophages are migratory cells that may be induced to migrate to given stimuli. Liposomal preparations that incorporate chemoattractants may be of value. Naturally occurring vesicles shed from dying cells have been shown to attract macrophages [62-64] but this is a prelude to a tolerogenic event [37]. However, the incorporation of

established chemoattractants for macrophages (that may also be activators) is of potential benefit in promoting APC involvement.

2. Interaction with APC: APC constitutively sample their environment and the ability of a liposome to interact with an APC will be an essential pre-requisite to subsequent steps. The nature of the uptake may be important too. Liposomes that drive fusion with APC plasma membranes (so called fusogenic liposomes) will deliver their contents to the cytoplasm of APC, an event that is likely to promote involvement of MHC class I and Tc lymphocytes. However, liposomes that drive their own phagocytic uptake (e.g. via scavenger receptors or other innate immune receptors) will promote class II MHC involvement and, via cross presentation, class I MHC. Thus targeting of liposomes to different uptake pathways may provide a mechanism for tailoring of immune responses.
3. APC Activation/Maturation: the activation of otherwise quiescent APC is a key event in driving protective immune responses. Liposome formulations that mediate this activation e.g. through ligation of PRR (that may also mediate interaction with and uptake of liposomes) are likely to be active assuming they are capable of targeting APC. It is the targeting of this step of the process that has driven adjuvant formulations to target the most highly studied PRR the TLRs.

Therefore to manipulate liposomes further to drive their interaction with DC and macrophages inclusion of components which are immunomodulatory to the innate immune system can be considered. Due to their versatile structure, it is easy to include various lipophilic components such as bacterial derived glycolipids in the bilayered membrane, or surface bound nucleotide based molecules, both of which are known to stimulate the immune system. In particular, the use of in toll-like receptors and their natural and synthetic agonists, many of which can be incorporated into liposome design with the aim to produce immunostimulatory antigen delivery systems. Similarly, there is the option of tagging liposomes with Ig to drive ligation with Fc receptors or sugars to drive interactions with lectin like molecules on APC. Despite all the significant insight into the interaction of cells, pathogens and liposomes with APC, it seems likely that there will not be a single, simple feature that can be used to promote liposome/APC interactions and drive immunogenic responses. Indeed a variety of liposome formulations may likely permit different, tailored immune responses to be promoted that might be beneficial for individual diseases.

### **3. Using liposomes to deliver nucleic acid-based vaccines**

In addition to subunit vaccines, nucleic acid based formulations also have the potential to circumvent many of the limitations of live and inactivated vaccines. The advantages of nucleic acids as the active component of a vaccine are evident when the mechanics of their activity are understood. To start, out of an entire pathogenic genome, we are aware of specific genes that encode for antigenic proteins that can then be isolated [65]. In many cases where pathogens have numerous antigenic sites the most preferred antigen for a safe and comprehensive immune response may be chosen and its gene sequence isolated. By amplifying and expressing this gene encoding antigen, purified samples of the selected antigen can be produced. Importantly, by introducing the isolated gene into the host organism itself the genetic material can be taken up by the host cells and expressed *in vivo*. The cell can then use its own components and apparatus to synthesize the antigen [66]. A major benefit to this is that the internal production of antigen allows for the antigen to be introduced to the immune system via the MHC class-I pathway [65] while still allowing for the traditional MHC class-II pathway to act [66]. Transforming host cells into antigen producers has other benefits: first, the production of new antigen within the host over time means that the initial dose load can be reduced [67], this initial dose may also provide a longer term protection in some cases removing previous need for boosters [68]. These vaccine formulations also bypass the major limiting factor of attenuated vaccines - the complexity of some pathogenic genomes. As that genome is being reduced to the bare essential antigenic coding sequences before dosing, potentially any pathogen for which the genome has been mapped could be converted into a nucleic acid vaccine.

Despite the above advantages DNA vaccines initially performed poorly in clinical trials; however, a small number of DNA vaccine products have now been approved, but all in the veterinary field [69]. More recently, self-amplifying RNA technology is showing the strongest promise. The use of RNA offers advantages in terms of their simple structure, the fact they can be delivered directly into the cytoplasm, and they do not require nuclear localisation to generate expression [70]. These systems have been shown to promote strong responses, for example Geall et al., [71], used lipid nanoparticles to deliver the RNA encoding respiratory syncytial virus fusion glycoprotein (RSV) and found this system promoted broad, potent and protective immune responses [71].

With these nucleic-acid based vaccines, how the genetic material is introduced into the host is an important factor for consideration. While free DNA is able to transfect cells and methodologies have been devised to facilitate its uptake without a vector [72], it has been shown that vector-delivered DNA vaccines have a higher efficacy [73]. Introducing foreign free DNA to the host without any

protective coating vector raises the potential for an improper immune response. Instead of the DNA reaching the target cells, being transfected and producing the necessary antigen, the DNA can instead be recognised as an antigen itself. Toll-like receptor 3 has been shown to recognise viral double-stranded DNA as an antigen [74], while Toll-like receptor 7 [75] and Toll-like receptor 8 [76] recognises viral single-stranded RNA. In this case the immune system would then mount an immune response not against the chosen antigen but for the genetic material that encodes that antigen; the desired antigen-binding antibodies being replaced with anti-DNA antibodies, although not at high enough levels to cause any auto-immune complications [77]. An additional problem is one of stability. For RNA, naked insertion into a host system can lead to quick degradation, limiting the vaccines ability to spread in the extracellular environment [78]. To avoid these limitations a form of protective vector construct must be used to deliver the genetic material to the target in the way that a pathogen would. This vector may also need a different cellular uptake pathway to sub-unit systems described above given that we require production of the antigen in the first instance. There are numerous approaches to be considered in this field; among them antibody derived vectors [79], viral envelope derived vectors [80] and carbon nanotube carrier vectors [81]. Each approach will, with further investigation, present its own array of advantages and disadvantages surrounding their compositions, delivery mechanics and vector-genetic material interactions. Taking viral-like vectors as an example, inappropriate management of surface components may limit effectiveness.

In developing a vaccine that utilises nucleic acid components, the vector must be effectively designed so that it can interact with, protect and deliver this material to targets as efficiently as possible. In order to achieve this, a vector design system allowing for a high degree of customisation to allow for these variables is needed; liposomes have numerous factors that make them suitable vectors for nucleic acid delivery. Their components, characteristics and additional elements can be altered and characterised so that an optimal DNA or RNA delivery mechanism can be created. To start, the lipid components suitable for this purpose are limited by a few factors. Importantly, charge dynamics have to be considered. Nucleic acids are anionic in nature; therefore for strong vector/vaccine interactions to occur the liposomes must contain a component that is cationic to provide a charged bonding between the two constituent elements. Cationic liposomes have been shown to make effective vectors [82] with several lipids capable of fulfilling the role of cationic component. However an issue with cationic liposomes is that of toxicity. Some cationic lipids have been shown to have greater immunogenic effects than others, such as DDA [83] and stearylamine [84]; many of the formulations used today using DOTAP, DOTMA and DC-Chol have in comparison been shown to have limited immunogenicity [85]. There is also evidence that cationic lipids of an anti-inflammatory effect [86],

which could result in a down-regulation of macrophage activity at the site of injection leading to an altered immune response pathway.

In addition to a cationic factor, to create a formulation that has a greater transfection efficacy it is advisable to include a component to facilitate this. Fusogenic lipids create membrane/membrane interactions that facilitate the incorporation of the liposome into the target cell. Choice of fusogenic lipid component is shown to be important, as DOPC has been observed to create these interaction structures much less effectively than DOPE [87]. Thus formulations consisting of an effective cationic lipid and effective fusogenic lipid exhibit two of the major desired factors of a vector: interaction potential with the loaded genetic material and an effective method of introducing the load to a target. With these main lipid components considered, additional components of other origins can be included to further optimise or specialise the liposomal vector. PEG or PEGylated lipids can be incorporated, although it can be seen to act as a double-edged sword. While by intending to shield the surface of the liposomes from host immune interaction it can increase the lipoplexes' ability to travel in circulation [88], it conversely can decrease transfection and endosomal escape efficacy by the same surface-shielding mechanism [89].

#### **4. New methods for testing liposomal vaccine adjuvants**

To date, animal usage is in the forefront to evaluate immune response or immunogenicity of vaccine antigens with different adjuvants. However, a number of problems are encountered in the use of animal models such as the lack of reliable animal models, biological differences between animal models, differences in animal species and difference in responses of animal strains within the same species to various adjuvants. Most importantly, a major challenge to the generation of liposome adjuvants is the high use of animals required to test novel formulations from an early stage. Similarly, use of animals will have a major effect on cost effectiveness limiting the current in vivo screens for rapid liposome adjuvants development in future. To scale up liposome screening and maximize the benefit to human health using current approaches, large numbers of animals are necessary and the cost (in animals, cash and man-hours) is prohibitive. So, to look for in vitro testing methods may be a best alternative to screen large libraries of putative liposome adjuvant systems. Use of in vitro methods as a replacement for animal usage will also help in reducing the animal usage in early stage compound screening. However, ultimately animal testing of lead liposome adjuvants will be essential due to the regulatory requirements of vaccine development.

Dissecting the interaction of liposome adjuvants in vitro with important components of the innate immune system to define cellular and molecular mechanisms of action is a simple but promising approach that helps to assess behaviour of the liposome adjuvant formulation rapidly. As outlined above, induction of an immune response involves uptake and presentation of antigens in secondary lymphoid tissue, a key step that involves professional antigen presenting cells (APC: dendritic cells: DC; and macrophages: MØ).

Antigen persistence (a 'depot' effect) is important in immune stimulation and transport of antigen to lymph nodes occurs via cellular transport where upon introduction of an antigenic compound, through infection or immunization, immature resident and recruited APC will take up antigen and transport it to local draining lymph nodes. Thus an initial step in the process may involve attraction of APC to the antigen. This will then be followed by interaction and then activation of APC. Methods for assessing each of these are outlined below.

**ATTRACTION** is the ability of liposome adjuvant preparations to attract APC and may be screened in a variety of ways e.g. through the use of real-time cell migration system for the assay of directional cell migration or through the use of higher-throughput transwell-based systems using automated screening (e.g. the Cell-IQ system). Importantly the attraction of APC to sites of liposome injection will likely be crucial to the development of the depot effect that is highlighted as important to successful in vivo efficacy of preparations. Many studies have shown migration of APC (e.g. macrophages) towards established chemoattractants (e.g. MCP-1, apoptotic cells and apoptotic cell-derived microparticles) [62-64, 90, 91]. Here, migration speed and direction of the APC cultured on glass cover slips can be assessed by exposing them to liposomes (or other putative attractant) in a Dunn chamber chemotaxis system with live video microscopy. Typical data generated from these microscopy studies is shown in figure 3. Our unpublished data has also shown differential migrational ability of macrophages and dendritic cells to different liposome adjuvant formulations using our Cell-IQ (Chipman Technologies) system or fully motorized, environment-controlled inverted DIC-microscopy system (Zeiss). Thus applying this unique assay to in vitro bio-analyses of liposomes will be ideal to assess APC attraction towards the antigen.

**INTERACTION** the ability of liposomes to associate with APC over time. Attraction of APC towards liposome adjuvants will be followed by INTERACTION with the antigen/adjuvant and this can be assessed by flow cytometry based approaches. Association of fluorescent (e.g. DiIC-labelled) liposomes when co-incubated with APC can be assessed by flow cytometric analysis [92]. Using this

approach, we have shown (figure 4) that liposome modulation by the addition of cholesterol (DDA:chol:TDB at 8:2:1 or 8:4:1 molar ratio) dramatically reduces interaction with M $\phi$  over time [92]. Importantly, this assay result correlates with a reduced ability for re-stimulated splenocytes of immunized animals to produce IFN- $\gamma$  and IL-2, important correlates of protective immunity (figure 5). Several studies have shown that IFN- $\gamma$  production is important for TB vaccine efficacy [42, 93] [94]. Furthermore, binding of internalized liposomes can be dissected through quenching surface bound fluorescence with trypan blue (to reveal only the fluorescent signal from internalized liposomes). Similarly, interaction assay can be undertaken at low temperature (non-permissive for particle uptake) to reveal only binding of liposomes to APC. This can also be carried out with antigen-loaded (adsorbed to the liposome surface or loaded in the core) liposomes and measures of fluorescent antigen can also be undertaken with multi-colour flow cytometry. These approaches are similarly adaptable to conventional fluorescence microscopy.

**ACTIVATION/MATURATION.** APC continuously sample their environment through uptake of material yet they do not constitutively induce responses, as they are quiescent. ACTIVATION from this quiescent state (by adjuvants with immunization without the need for PRR activation [95]; or damage, danger, PAMPs in natural infections) is a further crucial step in the generation of immune responses. A number of in vivo studies have shown that, following injection, DDA-based liposomes form a vaccine depot that mediates continuous attraction of APC to the site of injection [18] [26] [13] and that this depot effect correlates with immune response. These APC associate with liposomes and engulf, process and present the vaccine antigen and concomitantly become activated (assessed by up-regulation of co-stimulatory molecules CD40 and CD86 [13]).

The ability of liposomes to induce maturation and activation of APC is the critical event and can be assessed: (a) through immunofluorescence staining for key cell surface molecules/differentiation markers (CD14; MHC class II, CD1a, CD40, CD80, CD83, CD86, CD209) by multi-colour flow cytometry; (b) through the use of a multiplex cytokine assay screen by using either a flow cytometry-based or luminex based commercially available multiplex assay kits.

Any single screen will be limited in its usefulness in predicting in vivo efficacy of any given adjuvant preparation. An in vitro multiplex screen of key events that are essential for effective adjuvant function in vivo is required and a detailed in vitro multiplex analysis of liposome formulations with known in vivo efficacy is required to identify the necessary key tests. Given the significant in vivo



testing of liposomes that has been undertaken in labs, including our own, around the world, this in vitro correlation is an important piece of work to be undertaken.

**5. Manufacturing hurdles faced in the progression of liposomal adjuvants to the market.**

In addition to effective testing of these systems, in the translation of liposomal adjuvants from laboratory studies to market a key rate-limiting factor has been the cost effective production of a stabilised product. As with liposomes for drug delivery, the physicochemical properties of the liposomes are critical to ensure efficacy and product quality and these physicochemical properties are influenced by the manufacturing method adopted. Therefore, it is vital that the critical quality attributes and the critical process parameters in their manufacture are identified for the target liposome product profile. Indeed, a particular issue related to the production of liposomal products is their sensitivity to changes in the manufacturing conditions, including changes in scale; if there are changes in critical manufacturing parameters, complete characterisation of the liposomal product is recommended and this can include in vivo studies. Therefore, to tackle this issue new methods for the production of liposomal adjuvants are required.

The first method for preparing liposomes in the laboratory remains popular to-date and is based on a simple lipid film hydration method described in the 1960s [96, 97]; this method can easily be adapted for a variety of lipid molecules in order to form liposomes. Here, lipid molecules are dissolved in an appropriate solvent, usually a mix of chloroform and methanol, which is evaporated under vacuum, leaving a dried lipid film on the bottom of a flask [96, 97]. Residues of solvent are eliminated by flushing the dried lipid film under a stream of nitrogen. Subsequent hydration with an aqueous buffer together with agitation allows for assembly of the lipid molecules into large multilamellar vesicles (MLV). The hydration is performed above the transition temperature of the lipids, in order to maintain the formation of the vesicles [96, 98]. Resulting MLV are usually highly polydisperse, varying in size and shape. However, the obvious limitation of this method for industrial high-throughput manufacturing is scalability and controlling the resulting vesicle size which is dictated by the choice of lipids, the aqueous hydration step and the temperatures [96, 99]. To reduce and control vesicle size, several downsizing methods are available; the most frequently applied ones include sonication, extrusion, high shear or high pressure homogenization, and microfluidizer methods.

For large scale production, methods based on high shear fluid processors (e.g. Microfluidizer®) have been developed. Preformed MLV of high polydispersities are lead through an intensifier pump into the interaction chamber. Here, a high shear and high impact zone is created with shear rates up to  $10^7$

s<sup>-1</sup> and channel dimensions between typically 50-300 microns [100]. The applied shear force deforms the fluid followed by the impact, where collision of the particles is induced (Figure 6A). The turbulences and high shear forces triggers the size reduction of the MLV into SUV [101], where the size of resulting liposomes is dictated by the number of cycles and pressures. This temperature-controlled method allows for reduction of the liposome size down to 50 nm in diameter. Scalability has been demonstrated, and the methods are frequently applied for size reduction of emulsions, suspensions and liposome formulations. Nevertheless, the high shear forces may not be applicable for shear sensitive DNA or protein antigens [98, 102].

### **5.1 Manufacture of liposomal adjuvants using microfluidics**

Liposomes generated by fluidics-methods are based on the replacement of the solvent by addition of the aqueous phase and can be seen as an extension of the ethanol injection method [103]. In this method, the formation of SUV is based on a precipitation of the lipids, once in contact with the aqueous media. The liposome size is controlled by defined injection rates [104] and resulting liposome sizes can be tightly regulated. Methods based on the controlled fluid handling have been developed to increase the process robustness and manufacturing limitations of top-down methods. Solvents used are often less harsh than in the mechanical top-down methods, allowing for a simpler transfer into large-scale production. The rapid injection of the aqueous media into the solvent stream leads to a subsequent precipitation of the lipids, forming liposomes. Those methods based on rapid injection are common practice for large scale manufacturing of liposomes; mainly due to their scalability, flexibility and ease of application [102, 105]. In contrast to the mechanical “top-down” methods, the fluid injection methods can be categorized as “bottom-up” methods; as the precipitation leads to the formation of SUV without the need of further introducing mechanical forces for subsequent size reduction.

Microfluidics-based methods are adapted methods of fluid-controlled bottom-up methods, reported for precise control of liposome sizes and have been developed to circumvent the lack of process robustness and control in mentioned top-down methods and aid the process development on a small-footprint high-throughput device. Microfluidics generally considers fluid volumes handled in a constrained volume, allowing for precise control of mixing and flow rates and achieving a tight control of mixing rates, dominated by diffusion in a laminar flow profile. The rising demand of high-throughput tools in pharmaceutical and biopharmaceutical development led to an increase in number of microfluidics-based methodologies [106, 107]. Besides the enhanced process control, microfluidics-based methods allow for a robust and reproducible liposome manufacturing, based on the controlled

polarity increase in the chamber. It has been suggested that the formation of liposomes is driven by a nanoprecipitation reaction, where after supersaturation aggregation of the lipid molecules dominates once diluted beyond their aqueous solubility, striving the formation of the smallest particle size possible. Here, the liposomes formation is dependent on the ratio and flow rates of solvent and aqueous streams, which takes place at laminar flow conditions and mixing is driven by diffusion and chaotic advection. The tight control of the resulting liposome sizes is triggered by laminar flow profiles in the microfluidic chambers.

Microfluidic-based methods can be used to replicate a large scale process on a chip in microscale. One example is the liposome extrusion process, which is used on a large scale for size reduction of multilamellar liposomes by several passages through a membrane [108]. A liposome extrusion process on a chip has been developed, where lipid vesicles and tubes were manufactured, combining top-down and bottom-up vesicle manufacturing in an on-chip design. The pressure difference was one factor shown to contribute to the overall form of the final lipid vesicles [109]. A further adaptation into microscale from large-scale liposome manufacturing is the development of an on-chip double emulsion method. This involves, initial formation of a lipid emulsion followed by removal of the oil phase. Lipid monolayers formed at the interfaces assemble to lipid bilayer vesicles. This process has been translated into a microfluidic device, with a less harsh solvent than in the conventional double emulsion method allowing for higher biocompatibility [110]. This method was successfully shown to encapsulate protein, microbeads and cells [111]. The variable encapsulation efficiency was shown to depend on applied flow rates during the emulsification process, a user-controlled factor emphasizing the adaptability of microfluidic processes.

The flow-focusing technique [112-114] allows for a centred stream of solvent within two streams of polar phase. The diffusively driven process is the basis for controlled sizes for resulting particles (Figure 6B). The volumetric flow rates dictate the sizes of the resulting hydrodynamically focused solvent stream, where solvent dilutions result in self-assembly of the liposomes. The width of the hydrodynamically focused lipid-stream is proportional to the flow rates applied in the system. Liposomes manufactured with the hydrodynamic focusing method range between 50-150 nm in size. The channel depth and aspect ratio has been shown to strongly influence the resulting velocity profile homogeneity as well as surface effects [112, 113, 115]. The process of liposome formation is continuous, with the size dependent on flow ratios of aqueous and solvent phase and flow rates. Nevertheless, applied flow rate ratios between 10 to 60 will lead to a dilution of the final liposome

formulation and might necessitate a concentration step post formation. Flow rates reported are as low as 200 mm/sec [116, 117].

A passive micromixer based on chaotic advection [118] has also been applied for size-controlled synthesis of liposomes and lipid nanoparticles (Figure 6c). Higher flow rate ratios are reported to result in smaller liposome particles, driven by the overall lower amount of residual solvent present, reducing particle fusion (Ostwald ripening). Optimal flow rate ratios reported range around 3, with reduces the dilution effect opposed to higher ratios employed in the flow-focusing method [119]. Diffusional mixing is enhanced by the herringbone structures on the channel wall, resulting in much quicker mixing profiles compared to the flow-focusing technique. Here, the flow ratio of aqueous to solvent stream has been associated as the most influential factor contributing to the final size distribution of resulting liposome formulation [120], allowing for combined liposome manufacturing and drug encapsulation in a single process step [121].

In both methods, chaotic advection micromixer and flow focusing, the scalability of respective method has been shown and associated with constant vesicle sizes throughout a range of flow rates at constant flow ratios [115, 122]. The SHM method was shown to reproducibly manufacture SUV of controlled sizes at flow rates higher than 70 mL/min by parallelization of the mixers (scale-out). Overall, flow rates applied with the chaotic advection method are higher yielding a higher throughput. Furthermore, dilution is much higher in the flow focusing method with flow ratios ranging up to 60, whereas in a chaotic advection process a ratio of 3 was shown to yield the smallest vesicle size possible. Generally, bottom-up methods allow for a higher degree of process control and uniformity of resulting vesicles, circumventing the manufacturing process as the rate limiting factor in liposome manufacturing.

## **5.2 Implementing quality in liposomal adjuvant manufacturing by Quality by Design.**

Along with recent trends in the pharmaceutical sector, Quality by Design (QbD) principles have been investigated for liposomal products, generating a robust and reproducible design space that allows for controlled liposome quality characteristics. QbD principles aid the formulation process and evaluate the critical variables in a process, with the overall aim of applying statistical process control for achieving an enhanced product quality. A recent study investigated the effect of lipid chain length, lipid and drug concentration on the drug encapsulation efficiency. These parameters were furthermore linked to the liposome particle size, zeta-potential, as well as drug encapsulation efficiency in a response surface model. Here, the link between manufacturing method and particle

size was determined statistically, and furthermore linked the amount of drug encapsulated to a uni-lamellar vesicle structure [123]. Furthermore, a QbD study on liposomes investigated initially eight variables (lipid concentration, drug concentration, cholesterol concentration, buffer concentration, hydration time, sonication time, freeze–thaw cycles and extrusion pressure) on their effect to the critical liposome characteristics size, stability and drug encapsulation. The study revealed that the lipid and drug concentration had the main effect on the drug encapsulation efficiency [124]. Those studies give an example of how QbD principles may be used for aiding process understanding and optimizing a formulation. Nevertheless, results are dependent on the choice of lipids and drug and a design space requires optimization for each separate formulation.

However the above studies only considered the links for composition and manufacture to physico-chemical attributes. This is useful when the characteristics of a liposomal vaccine are identified. However, as we have discussed the correlation between physico-chemical attributes and vaccine efficacy is multi-factorial. Therefore in recent study, we used multivariate analysis (MVA) to consider correlations between key liposomal adjuvant characteristics to in-vivo immune responses [125]. Here, the main liposomal characteristics (liposome size, zeta potential) were determined by addition of a post-exposure fusion tuberculosis vaccine. In-vivo derived immunological performances (IgG, IgG1, IgG2b, spleen proliferation, IL-2, IL-5, IL-6, IL-10, IFN- $\gamma$ ) were clustered and linked to the characteristics of the adjuvant in a partial least square regression analysis and linked to the lipid composition. The model identified the drift towards a cell mediated immunity dependent on cationic lipid content and the resulting physicochemical liposome properties, exemplifying the use of chemometrics-based methods for aiding adjuvant design.

## **6. Conclusions**

New vaccines are required to offer improved worldwide healthcare. These vaccines should be safe, effective, affordable and accessible to the global population. Vaccine adjuvants play a key role in improving vaccine efficacy and stability. Liposomes, due to their proven clinical record as delivery systems and versatility, offer a strong adjuvant platform. Recent advances in manufacturing also make these a cost-effective option. However to continue to develop these systems as adjuvants we need to build a better understanding of the parameters that promote their efficacy, and this require us revisiting previously accepted paradigms in liposomal designs to take into account new advances in vaccinology. Using our new understanding of immune cell biology, we can modify liposomes not only effectively carrier antigens but also improve cellular interactions by targeting PRR to promote strong and appropriate immune cell activation. Furthermore, new development in manufacturing processes

now allow us to translate liposome production from the laboratory setting to industrial scale rapidly. However to improve the identification of effective adjuvants and speed their journey to market, new rapid in vitro pre-screen tools are need. Only through tackling all these issues can liposomal-adjuvants support the need for new vaccines.

## **7. Acknowledgements.**

EK was part funded by the EPSRC Centre for Innovative Manufacturing in Emergent Macromolecular Therapies and Aston University. FC was part funded by Novartis and Aston University. VN was funded through an Nc3R grant awarded to AD and YP.

## References

- [1] C.J. Murray, L.C. Rosenfeld, S.S. Lim, K.G. Andrews, K.J. Foreman, D. Haring, N. Fullman, M. Naghavi, R. Lozano, A.D. Lopez, Global malaria mortality between 1980 and 2010: a systematic analysis, *The Lancet*, 379 (2012) 413-431.
- [2] H.-W. Cho, C.R. Howard, H.-W. Lee, Review of an inactivated vaccine against hantaviruses, *Intervirology*, 45 (2001) 328-333.
- [3] P.R. Johnson, S. Feldman, J.M. Thompson, J.D. Mahoney, P.F. Wright, Immunity to influenza A virus infection in young children: a comparison of natural infection, live cold-adapted vaccine, and inactivated vaccine, *Journal of Infectious Diseases*, 154 (1986) 121-127.
- [4] D.P. Nayak, Genetic variation among influenza viruses, Academic Press, 2013.
- [5] R. Rappuoli, C.W. Mandl, S. Black, E. De Gregorio, Vaccines for the twenty-first century society, *Nature Reviews Immunology*, 11 (2011) 865-872.
- [6] A. Allison, G. Gregoriadis, Liposomes as immunological adjuvants, (1974).
- [7] A. Baillie, A. Florence, L. Hume, G. Muirhead, A. Rogerson, The preparation and properties of niosomes—non-ionic surfactant vesicles, *Journal of pharmacy and pharmacology*, 37 (1985) 863-868.
- [8] J. Almeida, D.C. Edwards, C. Brand, T. Heath, Formation of virosomes from influenza subunits and liposomes, *The Lancet*, 306 (1975) 899-901.
- [9] M. Conacher, J. Alexander, J.M. Brewer, Oral immunisation with peptide and protein antigens by formulation in lipid vesicles incorporating bile salts (bilosomes), *Vaccine*, 19 (2001) 2965-2974.
- [10] S. Calcagnile, G.V. Zuccotti, The virosomal adjuvanted influenza vaccine, *Expert opinion on biological therapy*, 10 (2010) 191-200.
- [11] M.-L. De Temmerman, J. Rejman, J. Demeester, D.J. Irvine, B. Gander, S.C. De Smedt, Particulate vaccines: on the quest for optimal delivery and immune response, *Drug discovery today*, 16 (2011) 569-582.
- [12] T. Mazumdar, K. Anam, N. Ali, Influence of phospholipid composition on the adjuvanticity and protective efficacy of liposome-encapsulated *Leishmania donovani* antigens, *Journal of Parasitology*, 91 (2005) 269-274.
- [13] D. Christensen, M. Henriksen-Lacey, A.T. Kamath, T. Lindenstrom, K.S. Korsholm, J.P. Christensen, A.F. Rochat, P.H. Lambert, P. Andersen, C.A. Siegrist, Y. Perrie, E.M. Agger, A cationic vaccine adjuvant based on a saturated quaternary ammonium lipid have different in vivo distribution kinetics and display a distinct CD4 T cell-inducing capacity compared to its unsaturated analog, *Journal of controlled release : official journal of the Controlled Release Society*, 160 (2012) 468-476.
- [14] D.A. Mannock, M.Y.T. Lee, R.N.A.H. Lewis, R.N. McElhaney, Comparative calorimetric and spectroscopic studies of the effects of cholesterol and epicholesterol on the thermotropic phase behaviour of dipalmitoylphosphatidylcholine bilayer membranes, *Biochimica et Biophysica Acta (BBA) - Biomembranes* 1778 (2008) 2191-2202
- [15] A.J. van Houte, H. Snippe, M.G. Schmitz, J.M. Willers, Characterization of immunogenic properties of haptenated liposomal model membranes in mice. V. Effect of membrane composition on humoral and cellular immunogenicity., *Immunology*, 44 (1981) 561-568.
- [16] O. Bakouche, D. Gerlier, Enhancement of immunogenicity of tumour virus antigen by liposomes: the effect of lipid composition, *Immunology*, 58 (1986) 507-513.
- [17] Y. Nakano, M. Mori, H. Yamamura, S. Naito, H. Kato, M. Taneichi, Y. Tanaka, K. Komuro, T. Uchida, Cholesterol inclusion in liposomes affects induction of antigen-specific IgG and IgE antibody production in mice by a surface-linked liposomal antigen, *Bioconjugate Chemistry*, 13 (2002) 744-749.
- [18] R. Kaur, V.W. Bramwell, D.J. Kirby, Y. Perrie, Pegylation of DDA: TDB liposomal adjuvants reduces the vaccine depot effect and alters the Th1/Th2 immune responses, *Journal of controlled release*, 158 (2012) 72-77.
- [19] J.F.S. Mann, E. Shakir, K.C. Carter, A.B. Mullen, J. Alexander, V.A. Ferro, Lipid vesicle size of an oral influenza vaccine delivery vehicle influences the Th1/Th2 bias in the immune response and protection against infection, *Vaccine*, 27 (2009) 3643-3649.

- [20] J.M. Brewer, L. Tetley, J. Richmond, F.Y. Liew, J. Alexander, Lipid vesicle size determines the Th1 or Th2 response to entrapped antigen, *The Journal of Immunology*, 161 (1998) 4000-4007.
- [21] J.M. Brewer, K.G.J. Pollock, L. Tetley, D.G. Russell, Vesicle size influences the trafficking, processing, and presentation of antigens in lipid vesicles, *The Journal of Immunology*, 173 (2004) 6143-6150.
- [22] V. Manolova, A. Flace, M. Bauer, K. Schwarz, P. Saudan, M.F. Bachmann, Nanoparticles target distinct dendritic cell populations according to their size, *European journal of immunology*, 38 (2008) 1404-1413.
- [23] M.G. Carstens, M.G. Camps, M. Henriksen-Lacey, K. Franken, T.H. Ottenhoff, Y. Perrie, J.A. Bouwstra, F. Ossendorp, W. Jiskoot, Effect of vesicle size on tissue localization and immunogenicity of liposomal DNA vaccines, *Vaccine*, 29 (2011) 4761-4770.
- [24] M. Henriksen-Lacey, A. Devitt, Y. Perrie, The vesicle size of DDA: TDB liposomal adjuvants plays a role in the cell-mediated immune response but has no significant effect on antibody production, *Journal of controlled release*, 154 (2011) 131-137.
- [25] D. Gall, The adjuvant activity of aliphatic nitrogenous bases, *Immunology*, 11 (1966) 369-386.
- [26] M. Henriksen-Lacey, D. Christensen, V.W. Bramwell, T. Lindstrom, E.M. Agger, P. Andersen, Y. Perrie, Liposomal cationic charge and antigen adsorption are important properties for the efficient deposition of antigen at the injection site and ability of the vaccine to induce a CMI response, *Journal of controlled release : official journal of the Controlled Release Society*, 145 (2010) 102-108.
- [27] M.J. Hussain, A. Wilkinson, V.W. Bramwell, D. Christensen, Y. Perrie, Th1 immune responses can be modulated by varying dimethyldioctadecylammonium and distearoyl-sn-glycero-3-phosphocholine content in liposomal adjuvants, *Journal of Pharmacy and Pharmacology*, 66 (2014) 358-366.
- [28] M. Henriksen-Lacey, V.W. Bramwell, D. Christensen, E.-M. Agger, P. Andersen, Y. Perrie, Liposomes based on dimethyldioctadecylammonium promote a depot effect and enhance immunogenicity of soluble antigen, *Journal of controlled release*, 142 (2010) 180-186.
- [29] D.A. Norris, N. Puri, P.J. Sinko, The effect of physical barriers and properties on the oral absorption of particulates, *Adv Drug Deliv Rev*, 34 (1998) 135-154.
- [30] J.H. Eldridge, C.J. Hammond, J.A. Meulbroek, J.K. Staas, R.M. Gilley, T.R. Tice, Controlled vaccine release in the gut-associated lymphoid tissues. I. Orally administered biodegradable microspheres target the peyer's patches, *Journal of Controlled Release*, 11 (1990) 205-214.
- [31] M. Shakweh, M. Besnard, V.r. Nicolas, E. Fattal, Poly (lactide-co-glycolide) particles of different physicochemical properties and their uptake by peyer's patches in mice, *European Journal of Pharmaceutics and Biopharmaceutics*, 61 (2005) 1-13.
- [32] S. Gordon, Pattern recognition receptors: doubling up for the innate immune response, *Cell*, 111 (2002) 927-930.
- [33] P. Matzinger, The danger model: a renewed sense of self, *Science*, 296 (2002) 301-305.
- [34] C.A. Janeway, Jr., How the immune system works to protect the host from infection: a personal view, *Proc Natl Acad Sci U S A*, 98 (2001) 7461-7468.
- [35] G.E. Hammer, A. Ma, Molecular control of steady-state dendritic cell maturation and immune homeostasis, *Annu Rev Immunol*, 31 (2013) 743-791.
- [36] R.M. Steinman, S. Turley, I. Mellman, K. Inaba, The induction of tolerance by dendritic cells that have captured apoptotic cells, *J Exp Med*, 191 (2000) 411-416.
- [37] D.R. Green, T. Ferguson, L. Zitvogel, G. Kroemer, Immunogenic and tolerogenic cell death, *Nat Rev Immunol*, 9 (2009) 353-363.
- [38] A. Devitt, O.D. Moffatt, C. Raykundalia, J.D. Capra, D.L. Simmons, C.D. Gregory, Human CD14 mediates recognition and phagocytosis of apoptotic cells, *Nature*, 392 (1998) 505-509.
- [39] Y. Ren, R.L. Silverstein, J. Allen, J. Savill, CD36 gene transfer confers capacity for phagocytosis of cells undergoing apoptosis, *J Exp Med*, 181 (1995) 1857-1862.
- [40] S. Gnjatic, N.B. Sawhney, N. Bhardwaj, Toll-like receptor agonists: are they good adjuvants?, *Cancer journal*, 16 (2010) 382-391.



- [41] D.T. O'Hagan, E.D. Gregorio, The path to a successful vaccine adjuvant – 'The long and winding road', *Drug Discovery Today*, 14 (2009) 541-551.
- [42] E.M. Agger, I. Rosenkrands, J. Hansen, K. Brahimi, B.S. Vandahl, C. Aagaard, K. Werninghaus, C. Kirschning, R. Lang, D. Christensen, Cationic liposomes formulated with synthetic mycobacterial cordfactor (CAF01): a versatile adjuvant for vaccines with different immunological requirements, *PLoS one*, 3 (2008) e3116.
- [43] H. Yu, K.P. Karunakaran, X. Jiang, C. Shen, P. Andersen, R.C. Brunham, Chlamydia muridarum T cell antigens and adjuvants that induce protective immunity in mice, *Infection and immunity*, 80 (2012) 1510-1518.
- [44] P. Nordly, F. Rose, D. Christensen, H.M. Nielsen, P. Andersen, E.M. Agger, C. Foged, Immunity by formulation design: induction of high CD8+ T-cell responses by poly (I: C) incorporated into the CAF01 adjuvant via a double emulsion method, *Journal of Controlled Release*, 150 (2011) 307-317.
- [45] V. Bhowruth, D.E. Minnikin, E.M. Agger, P. Andersen, V.W. Bramwell, Y. Perrie, G.S. Besra, Adjuvant properties of a simplified C 32 monomycolyl glycerol analogue, *Bioorganic & medicinal chemistry letters*, 19 (2009) 2029-2032.
- [46] N. Garçon, P. Chomez, M. Van Mechelen, GlaxoSmithKline Adjuvant Systems in vaccines: concepts, achievements and perspectives, (2007).
- [47] P. Vandepapelière, Y. Horsmans, P. Moris, M. Van Mechelen, M. Janssens, M. Koutsoukos, P. Van Belle, F. Clement, E. Hanon, M. Wettendorff, Vaccine adjuvant systems containing monophosphoryl lipid A and QS21 induce strong and persistent humoral and T cell responses against hepatitis B surface antigen in healthy adult volunteers, *Vaccine*, 26 (2008) 1375-1386.
- [48] B. Agrawal, M.J. Krantz, M.A. Reddish, B.M. Longenecker, Rapid induction of primary human CD4+ and CD8+ T cell responses against cancer-associated MUC1 peptide epitopes, *International immunology*, 10 (1998) 1907-1916.
- [49] U.S.N.I.o. Health, Safety Study of a Liposomal Vaccine to Treat Malignant Melanoma, in, <https://clinicaltrials.gov/ct2/show/NCT01052142>.
- [50] L.A. Pestano, B. Christian, S. Koppenol, J. Millard, G. Christianson, K. Klucher, R. Rosler, S.R. Peterson, ONT-10, a liposomal vaccine targeting hypoglycosylated MUC1, induces a potent cellular and humoral response and suppresses the growth of MUC1 expressing tumors, in: Proceedings of the 102nd annual meeting of the american association for cancer research. Orlando, Florida, Philadelphia (PA): AACR, 2011.
- [51] T. Nakamura, D. Yamazaki, J. Yamauchi, H. Harashima, The nanoparticulation by octaarginine-modified liposome improves  $\alpha$ -galactosylceramide-mediated antitumor therapy via systemic administration, *Journal of Controlled Release*, 171 (2013) 216-224.
- [52] C. Wang, Y. Zhuang, Y. Zhang, Z. Luo, N. Gao, P. Li, H. Pan, L. Cai, Y. Ma, Toll-like receptor 3 agonist complexed with cationic liposome augments vaccine-elicited antitumor immunity by enhancing TLR3–IRF3 signaling and type I interferons in dendritic cells, *Vaccine*, 30 (2012) 4790-4799.
- [53] Z. Zhong, X. Wei, B. Qi, W. Xiao, L. Yang, Y. Wei, L. Chen, A novel liposomal vaccine improves humoral immunity and prevents tumor pulmonary metastasis in mice, *International journal of pharmaceuticals*, 399 (2010) 156-162.
- [54] J. Miyazaki, K. Kawai, T. Kojima, T. Oikawa, A. Joraku, T. Shimazui, A. Nakaya, I. Yano, T. Nakamura, H. Harashima, The liposome-incorporating cell wall skeleton of *Mycobacterium bovis* bacillus Calmette-Guérin can directly enhance the susceptibility of cancer cells to lymphokine-activated killer cells through up-regulation of natural-killer group 2, member D ligands, *BJU international*, 108 (2011) 1520-1526.
- [55] K. Senchi, S. Matsunaga, H. Hasegawa, H. Kimura, A. Ryo, Development of oligomannose-coated liposome-based nasal vaccine against human parainfluenza virus type 3, *Frontiers in microbiology*, 4 (2013).
- [56] Q. Ding, J. Chen, X. Wei, W. Sun, J. Mai, Y. Yang, Y. Xu, RAFTsomes containing epitope-MHC-II complexes mediated CD4+ T cell activation and antigen-specific immune responses, *Pharmaceutical research*, 30 (2013) 60-69.

- [57] P.-L. Jiang, H.-J. Lin, H.-W. Wang, W.-Y. Tsai, S.-F. Lin, M.-Y. Chien, P.-H. Liang, Y.-Y. Huang, D.-Z. Liu, Galactosylated liposome as a dendritic cell-targeted mucosal vaccine for inducing protective anti-tumor immunity, *Acta biomaterialia*, 11 (2015) 356-367.
- [58] R.S. Kallerup, C. Foged, Classification of Vaccines, in: *Subunit Vaccine Delivery*, Springer, 2015, pp. 15-29.
- [59] J.-S. Thomann, B. Heurtault, S. Weidner, M. Brayé, J. Beyrath, S. Fournel, F. Schuber, B. Frisch, Antitumor activity of liposomal ErbB2/HER2 epitope peptide-based vaccine constructs incorporating TLR agonists and mannose receptor targeting, *Biomaterials*, 32 (2011) 4574-4583.
- [60] X. Pan, L. Chen, S. Liu, X. Yang, J.-X. Gao, R.J. Lee, Antitumor activity of G3139 lipid nanoparticles (LNPs), *Molecular pharmaceuticals*, 6 (2008) 211-220.
- [61] P. Li, S. Chen, Y. Jiang, J. Jiang, Z. Zhang, X. Sun, Dendritic cell targeted liposomes–protamine–DNA complexes mediated by synthetic mannosylated cholesterol as a potential carrier for DNA vaccine, *Nanotechnology*, 24 (2013) 295101.
- [62] C. Segundo, F. Medina, C. Rodriguez, R. Martinez-Palencia, F. Leyva-Cobian, J.A. Brieva, Surface molecule loss and bleb formation by human germinal center B cells undergoing apoptosis: role of apoptotic blebs in monocyte chemotaxis, *Blood*, 94 (1999) 1012-1020.
- [63] L.A. Truman, C.A. Ogden, S.E. Howie, C.D. Gregory, Macrophage chemotaxis to apoptotic Burkitt's lymphoma cells in vitro: role of CD14 and CD36, *Immunobiology*, 209 (2004) 21-30.
- [64] E.E. Torr, D.H. Gardner, L. Thomas, D.M. Goodall, A. Bielemeier, R. Willetts, H.R. Griffiths, L.J. Marshall, A. Devitt, Apoptotic cell-derived ICAM-3 promotes both macrophage chemoattraction to and tethering of apoptotic cells, *Cell Death Differ*, 19 (2012) 671-679.
- [65] S. Hirschman, E. Garfinkel, S. Sugrue, Expression of hepatitis B viral antigens in animal cells transfected with viral DNA, *Transactions of the Association of American Physicians*, 95 (1981) 53-62.
- [66] T. Yoshikawa, S. Imazu, J.-Q. Gao, K. Hayashi, Y. Tsuda, M. Shimokawa, T. Sugita, T. Niwa, A. Oda, M. Akashi, Augmentation of antigen-specific immune responses using DNA-fusogenic liposome vaccine, *Biochemical and biophysical research communications*, 325 (2004) 500-505.
- [67] G. Grødeland, B. Bogen, Efficient vaccine against pandemic influenza: combining DNA vaccination and targeted delivery to MHC class II molecules, *Expert review of vaccines*, (2015) 1-10.
- [68] G.-J.J. Chang, A.R. Hunt, B. Davis, A single intramuscular injection of recombinant plasmid DNA induces protective immunity and prevents Japanese encephalitis in mice, *Journal of virology*, 74 (2000) 4244-4252.
- [69] M.A. Kutzler, D.B. Weiner, DNA vaccines: ready for prime time?, *Nature Reviews Genetics*, 9 (2008) 776-788.
- [70] D.B. Weiner, RNA-based vaccination: Sending a strong message, *Molecular Therapy*, 21 (2013) 506-508.
- [71] A.J. Geall, A. Verma, G.R. Otten, C.A. Shaw, A. Hekele, K. Banerjee, Y. Cu, C.W. Beard, L.A. Brito, T. Krucker, Nonviral delivery of self-amplifying RNA vaccines, *Proceedings of the National Academy of Sciences*, 109 (2012) 14604-14609.
- [72] D. Carlétti, D.M. da Fonseca, A.F. Gembre, A.P. Masson, L.W. Campos, L.C. Leite, A.R. Pires, J. Lannes-Vieira, C.L. Silva, V.L.D. Bonato, A Single Dose of a DNA Vaccine Encoding Apa Coencapsulated with 6, 6'-Trehalose Dimycolate in Microspheres Confers Long-Term Protection against Tuberculosis in Mycobacterium bovis BCG-Primed Mice, *Clinical and Vaccine Immunology*, 20 (2013) 1162-1169.
- [73] D.H. Amante, T.R. Smith, B.B. Kiosses, N.Y. Sardesai, L.M. Humeau, K.E. Broderick, Direct Transfection of Dendritic Cells in the Epidermis After Plasmid Delivery Enhanced by Surface Electroporation, *Human gene therapy methods*, 25 (2014) 315-316.
- [74] M.L. Knudsen, A. Mbewe-Mvula, M. Rosario, D.X. Johansson, M. Kakoulidou, A. Bridgeman, A. Reyes-Sandoval, A. Nicosia, K. Ljungberg, T. Hanke, Superior induction of T cell responses to conserved HIV-1 regions by electroporated alphavirus replicon DNA compared to that with conventional plasmid DNA vaccine, *Journal of virology*, 86 (2012) 4082-4090.

- [75] K.N. Schmidt, B. Leung, M. Kwong, K.A. Zarembler, S. Satyal, T.A. Navas, F. Wang, P.J. Godowski, APC-independent activation of NK cells by the Toll-like receptor 3 agonist double-stranded RNA, *The Journal of Immunology*, 172 (2004) 138-143.
- [76] J.A. Potter, M. Garg, S. Girard, V.M. Abrahams, Viral Single Stranded RNA Induces a Trophoblast Pro-Inflammatory and Antiviral Response in a TLR8-Dependent and-Independent Manner, *Biology of reproduction*, (2014) bioRxiv. 114.124032.
- [77] D. Xiong, L. Song, Z. Pan, X. Chen, S. Geng, X. Jiao, Identification and Immune Functional Characterization of Pigeon TLR7, *International journal of molecular sciences*, 16 (2015) 8364-8381.
- [78] G. Mor, M. Singla, A.D. Steinberg, S.L. Hoffman, K. Okuda, D.M. Klinman, Do DNA vaccines induce autoimmune disease?, *Human gene therapy*, 8 (1997) 293-300.
- [79] W.-F. Cheng, C.-F. Hung, C.-Y. Chai, K.-F. Hsu, L. He, M. Ling, T.-C. Wu, Enhancement of sindbis virus self-replicating RNA vaccine potency by linkage of herpes simplex virus type 1 VP22 protein to antigen, *Journal of virology*, 75 (2001) 2368-2376.
- [80] K. Muthumani, S. Flingai, M. Wise, C. Tingey, K.E. Ugen, D.B. Weiner, Optimized and enhanced DNA plasmid vector based in vivo construction of a neutralizing anti-HIV-1 envelope glycoprotein Fab, *Human vaccines & immunotherapeutics*, 9 (2013) 2253-2262.
- [81] H.-J. Lee, Y.-K. Hur, Y.-D. Cho, M.-G. Kim, H.-T. Lee, Y.-K. Oh, Y.B. Kim, Immunogenicity of bivalent human papillomavirus DNA vaccine using human endogenous retrovirus envelope-coated baculoviral vectors in mice and pigs, *PLoS one*, 7 (2012) e50296.
- [82] B. Zhu, G.-L. Liu, Y.-X. Gong, F. Ling, G.-X. Wang, Protective immunity of grass carp immunized with DNA vaccine encoding the vp7 gene of grass carp reovirus using carbon nanotubes as a carrier molecule, *Fish & shellfish immunology*, 42 (2015) 325-334.
- [83] K. Lappalainen, I. Jääskeläinen, K. Syrjänen, A. Urtti, S. Syrjänen, Comparison of cell proliferation and toxicity assays using two cationic liposomes, *Pharmaceutical research*, 11 (1994) 1127-1131.
- [84] P. Campbell, Toxicity of some charged lipids used in liposome preparations, *Cytobios*, 37 (1982) 21-26.
- [85] A. Masotti, G. Mossa, C. Cametti, G. Ortaggi, A. Bianco, N. Del Grosso, D. Malizia, C. Esposito, Comparison of different commercially available cationic liposome–DNA lipoplexes: Parameters influencing toxicity and transfection efficiency, *Colloids and Surfaces B: Biointerfaces*, 68 (2009) 136-144.
- [86] M.C. Fillion, N.C. Phillips, Anti-inflammatory activity of cationic lipids, *British journal of pharmacology*, 122 (1997) 551-557.
- [87] Z. Du, M.M. Munye, A.D. Tagalakis, M.D. Manunta, S.L. Hart, The Role of the Helper Lipid on the DNA Transfection Efficiency of Lipopolyplex Formulations, *Scientific reports*, 4 (2014).
- [88] T. Gjetting, N.S. Arildsen, C.L. Christensen, T.T. Poulsen, J.A. Roth, V.N. Handlos, H.S. Poulsen, In vitro and in vivo effects of polyethylene glycol (PEG)-modified lipid in DOTAP/cholesterol-mediated gene transfection, *International journal of nanomedicine*, 5 (2010) 371.
- [89] C.-L. Chan, R.N. Majzoub, R.S. Shirazi, K.K. Ewert, Y.-J. Chen, K.S. Liang, C.R. Safinya, Endosomal escape and transfection efficiency of PEGylated cationic liposome–DNA complexes prepared with an acid-labile PEG-lipid, *Biomaterials*, 33 (2012) 4928-4935.
- [90] V. Nadella, Z. Wang, T.S. Johnson, M. Griffin, A. Devitt, Transglutaminase 2 interacts with syndecan-4 and CD44 at the surface of human macrophages to promote removal of apoptotic cells, *Biochimica et biophysica acta*, 1853 (2015) 201-212.
- [91] L.A. Hawkins, A. Devitt, Current understanding of the mechanisms for clearance of apoptotic cells—a fine balance, *Journal of cell death*, 6 (2013) 57-68.
- [92] R. Kaur, M. Henriksen-Lacey, J. Wilkhu, A. Devitt, D. Christensen, Y. Perrie, Effect of incorporating cholesterol into DDA:TDB liposomal adjuvants on bilayer properties, biodistribution, and immune responses, *Molecular pharmaceutics*, 11 (2014) 197-207.
- [93] E.M. Agger, P. Andersen, Tuberculosis subunit vaccine development: on the role of interferon-gamma, *Vaccine*, 19 (2001) 2298-2302.

- [94] E.B. Lindblad, M.J. Elhay, R. Silva, R. Appelberg, P. Andersen, Adjuvant modulation of immune responses to tuberculosis subunit vaccines, *Infect Immun*, 65 (1997) 623-629.
- [95] A. Milicic, R. Kaur, A. Reyes-Sandoval, C.-K. Tang, J. Honeycutt, Y. Perrie, A.V. Hill, Small cationic DDA: TDB liposomes as protein vaccine adjuvants obviate the need for TLR agonists in inducing cellular and humoral responses, *PloS one*, 7 (2012) e34255.
- [96] A. Bangham, M.M. Standish, J. Watkins, Diffusion of univalent ions across the lamellae of swollen phospholipids, *Journal of molecular biology*, 13 (1965) 238-IN227.
- [97] A. Bangham, A correlation between surface charge and coagulant action of phospholipids, (1961).
- [98] F. Szoka Jr, D. Papahadjopoulos, Comparative properties and methods of preparation of lipid vesicles (liposomes), *Annual review of biophysics and bioengineering*, 9 (1980) 467-508.
- [99] G. Gregoriadis, A. Bacon, W. Caparros-Wanderley, B. McCormack, A role for liposomes in genetic vaccination, *Vaccine*, 20 (2002) B1-B9.
- [100] F.L. Sorgi, L. Huang, Large scale production of DC-Chol cationic liposomes by microfluidization, *International journal of pharmaceutics*, 144 (1996) 131-139.
- [101] R. Barnadas-Rodriguez, M. Sabes, Factors involved in the production of liposomes with a high-pressure homogenizer, *Int J Pharm*, 213 (2001) 175-186.
- [102] A. Wagner, K. Vorauer-Uhl, Liposome technology for industrial purposes, *J Drug Deliv*, 2011 (2011) 591325.
- [103] S. Batzri, E.D. Korn, Single bilayer liposomes prepared without sonication, *Biochimica et Biophysica Acta (BBA)-Biomembranes*, 298 (1973) 1015-1019.
- [104] S. Hauschild, U. Lipprandt, A. Rumpelcker, U. Borchert, A. Rank, R. Schubert, S. Förster, Direct preparation and loading of lipid and polymer vesicles using inkjets, *Small*, 1 (2005) 1177-1180.
- [105] R. Naeff, Feasibility of topical liposome drugs produced on an industrial scale, *Advanced drug delivery reviews*, 18 (1996) 343-347.
- [106] G.M. Whitesides, The origins and the future of microfluidics, *Nature*, 442 (2006) 368-373.
- [107] P.S. Dittrich, A. Manz, Lab-on-a-chip: microfluidics in drug discovery, *Nature Reviews Drug Discovery*, 5 (2006) 210-218.
- [108] F. Olson, C. Hunt, F. Szoka, W. Vail, D. Papahadjopoulos, Preparation of liposomes of defined size distribution by extrusion through polycarbonate membranes, *Biochimica et Biophysica Acta (BBA)-Biomembranes*, 557 (1979) 9-23.
- [109] P.S. Dittrich, M. Heule, P. Renaud, A. Manz, On-chip extrusion of lipid vesicles and tubes through micro-sized apertures, *Lab on a chip*, 6 (2006) 488-493.
- [110] S.-Y. Teh, R. Khnouf, H. Fan, A.P. Lee, Stable, biocompatible lipid vesicle generation by solvent extraction-based droplet microfluidics, *Biomicrofluidics*, 5 (2011) 044113.
- [111] Y.-C. Tan, K. Hettiarachchi, M. Siu, Y.-R. Pan, A.P. Lee, Controlled microfluidic encapsulation of cells, proteins, and microbeads in lipid vesicles, *Journal of the American Chemical Society*, 128 (2006) 5656-5658.
- [112] A. Jahn, S.M. Stavis, J.S. Hong, W.N. Vreeland, D.L. DeVoe, M. Gaitan, Microfluidic mixing and the formation of nanoscale lipid vesicles, *Acs Nano*, 4 (2010) 2077-2087.
- [113] A. Jahn, W.N. Vreeland, M. Gaitan, L.E. Locascio, Controlled vesicle self-assembly in microfluidic channels with hydrodynamic focusing, *Journal of the American Chemical Society*, 126 (2004) 2674-2675.
- [114] P.M. Valencia, P.A. Basto, L. Zhang, M. Rhee, R. Langer, O.C. Farokhzad, R. Karnik, Single-Step Assembly of Homogenous Lipid- Polymeric and Lipid- Quantum Dot Nanoparticles Enabled by Microfluidic Rapid Mixing, *ACS nano*, 4 (2010) 1671-1679.
- [115] A. Jahn, W.N. Vreeland, D.L. DeVoe, L.E. Locascio, M. Gaitan, Microfluidic directed formation of liposomes of controlled size, *Langmuir*, 23 (2007) 6289-6293.
- [116] T.A. Balbino, N.T. Aoki, A.A. Gasperini, C.L. Oliveira, A.R. Azzoni, L.P. Cavalcanti, L.G. de la Torre, Continuous flow production of cationic liposomes at high lipid concentration in microfluidic devices for gene delivery applications, *Chemical Engineering Journal*, 226 (2013) 423-433.

- [117] T.A. Balbino, A.R. Azzoni, L.G. de La Torre, Microfluidic devices for continuous production of pDNA/cationic liposome complexes for gene delivery and vaccine therapy, *Colloids and Surfaces B: Biointerfaces*, 111 (2013) 203-210.
- [118] A.D. Stroock, S.K. Dertinger, A. Ajdari, I. Mezić, H.A. Stone, G.M. Whitesides, Chaotic mixer for microchannels, *Science*, 295 (2002) 647-651.
- [119] I.V. Zhigaltsev, N. Belliveau, I. Hafez, A.K. Leung, J. Huft, C. Hansen, P.R. Cullis, Bottom-up design and synthesis of limit size lipid nanoparticle systems with aqueous and triglyceride cores using millisecond microfluidic mixing, *Langmuir*, 28 (2012) 3633-3640.
- [120] E. Kastner, R. Kaur, D. Lowry, B. Moghaddam, A. Wilkinson, Y. Perrie, High-throughput manufacturing of size-tuned liposomes by a new microfluidics method using enhanced statistical tools for characterization, *International Journal of Pharmaceutics*, (2014).
- [121] E. Kastner, V. Verma, D. Lowry, Y. Perrie, Microfluidic-controlled manufacture of liposomes for the solubilisation of a poorly water soluble drug, *International journal of pharmaceutics*, 485 (2015) 122-130.
- [122] N.M. Belliveau, J. Huft, P.J. Lin, S. Chen, A.K. Leung, T.J. Leaver, A.W. Wild, J.B. Lee, R.J. Taylor, Y.K. Tam, Microfluidic synthesis of highly potent limit-size lipid nanoparticles for in vivo delivery of siRNA, *Molecular Therapy—Nucleic Acids*, 1 (2012) e37.
- [123] X. Xu, M.A. Khan, D.J. Burgess, A quality by design (QbD) case study on liposomes containing hydrophilic API: I. Formulation, processing design and risk assessment, *International journal of pharmaceutics*, 419 (2011) 52-59.
- [124] X. Xu, M.A. Khan, D.J. Burgess, A quality by design (QbD) case study on liposomes containing hydrophilic API: II. Screening of critical variables, and establishment of design space at laboratory scale, *International journal of pharmaceutics*, 423 (2012) 543-553.
- [125] E. Kastner, M.J. Hussain, V.W. Bramwell, D. Christensen, Y. Perrie, Correlating liposomal adjuvant characteristics to in-vivo cell-mediated immunity using a novel *Mycobacterium tuberculosis* fusion protein: a multivariate analysis study, *Journal of Pharmacy and Pharmacology*, 67 (2015) 450-463.

## Figure legends.

**Figure 1.** Liposomal adjuvants may function through the formation of an antigen (Ag)-adjuvant depot that promotes antigen delivery, uptake by immature antigen presenting cells (APC) and cellular stimulation through pattern recognition receptors (PRR). This results in maturation of APC (up-regulation of MHC II and co-stimulatory molecules) and antigen processing and presentation.

**Figure 2.** Key physico-chemical features of liposomes that can influence their efficacy as vaccine adjuvants including bilayer rigidity [12,13,14,15,16,17,18], vesicle size vesicles [19-23], biodistribution [24], biodistribution, antigen location [25] and vesicle charge [31]

**Figure 3.** Analysis of APC migration. Macrophages seeded to glass coverslips and loaded to a Dunn chemotaxis chamber are followed for their migration towards a putative attractant. The migration of cells is assessed using time-lapse photomicrography over two hours and the path taken by each cell is superimposed on the plot shown. The starting point of each cell is mapped onto the cross hairs, the final position of the cell is shown by the black circle and the route shown in between. Blue dot: relative position of the attractant.

**Figure 4:** Liposomes modified by the addition of cholesterol show reduced interaction with macrophages. THP-1 cell derived macrophages were incubated with fluorescent (diIC)-labelled liposomes and the interaction of fluorescent liposomes with macrophages was assessed by flow cytometry. Data shown are the mean or Mean Fluorescence Intensity (MFI) versus % of cells positive for fluorescence from three independent experiments. Three DDA:Cholesterol:TDB liposome formulations were used at molar ratios of 8:0:1 (blue); 8:2:1 (green) and 8:4:1 (red). Results for macrophages alone are shown in black. Addition of cholesterol significantly reduces liposome interaction.

**Figure 5:** Liposomes modified by the addition of cholesterol generate reduced antigen-specific cytokine responses. Mice (n=5) were immunised with Ag in formulation with the indicated DDA:cholesterol:TDB liposomes. Ex vivo splenocyte cytokine production was assessed. Data shown are mean  $\pm$  SEM. Response from Ag-only immunisation: IFN = 100 $\pm$ 90 pg/ml; IL2 = 88 $\pm$ 88pg/ml.

**Figure 6:** Novel methods for large scale production of liposomes. A) high shear fluid processors where preformed MLV are subjected to a high shear and high impact zone. The applied shear force deforms

the fluid followed by the impact, where collision of the particles is induced to reduce vesicle size. Vesicle size is controlled by the number of cycles and pressures. Microfluidics systems using B) flow focusing or C) chaotic advection micromixer where vesicle size can be controlled through flow rates and flow ratios.

**Table 1:** Examples of recent studies involving PAMP containing liposomal formulations.

Principle Lipid	PAMP	PRR	Immune response	Reference
CAF01 (DDA)	TDB	Mincle	IgG2 production, Th1/Th17 activation	[42]
CAF04 (DDA)	MMG	Non-TLR	moderate levels of IFN- $\gamma$ - or TNF- $\alpha$ -producing CD4+ T cells	[43]
CAF05 (DDA)	TDB / Poly I:C	Mincle / TLR3	CD4 and CD8 cross-primed T cell response	[44]
CAF06 (DDA)	TDB / MPL	Mincle / TLR4	CD8 T Cell and Humoral Ab Response	[44]
CAF09 (DDA)	MMG	Non-TLR	Strong Cross-Primed Th1, Th17, IgG1and IgG2 response	[45]
AS01 (Proprietary)	MPL	TLR4	Th1 and anti-malarial Ab response	[46]
AS01b (Proprietary)	MPL / QS-21	TLR4 / Non-TLR?	Specific and persistent humoral, CD4 and CD8 response	[47]
Tecemotide (Stimuvax) [L-BLP25]	MPL	TLR4	Th1 and CD8 response to antigen	[48]
Lipovaxin-MM (Proprietary)	Fg115 / Lipokel (Proprietary)	TLR5 / TLR2	---	[49]
ONT-10	PET Lipid A	TLR4	Th1 and CD8 response to antigen, IgG2b	[50]
pegPC / Cholestrol / Octa-arginine SA	Alpha-galactosyl ceramide	NK associated TLRs	Natural Killer cell activation, tumour targeting	[51]
DOTAP-PIC	Poly I:C	TLR3	Tumour specific CTL, IFN gamma production	[52]
DOPE / DOTAP	MP Lipid A	TLR4	bFGF-associated metastasis inhibition	[53]



PC / Cholesterol	BCG-CWS	TLR2 /TLR4	Effective carcinoma targeting	[54]
DPPC / Cholesterol	Poly I:C / Oligomannose	TLR3 / MBL	High specific IgG and IgA response	[55]
RAFTsomes	MHCII complex microdomain	CD4	High specific IgG1 production	[56]
PC / Cholesterol	Galactosyl-DLPE	MGL	Specific Ab and IL 4/5/6 response	[57]
DDA	trehalose 6,6'-diester analogues	Mincle	TDB-Comparable T-Cell responses	[58]
Mannosylated ErbB2/HER2 peptide Liposomes	Pam3CAG / PAM2CGD	TLR 1/2/6	Effective CTL Anti-tumour response	[59]
PC / DC-chol / pegDSPE / Protamine	Oblimersen G3139 oligonucleotide	TLR9	NK and DC driven anti-tumour response	[60]
DDAB / Cholesterol	Mannosylated Cholesterol	MBL	DC CD40 and CD80 upregulation	[61]

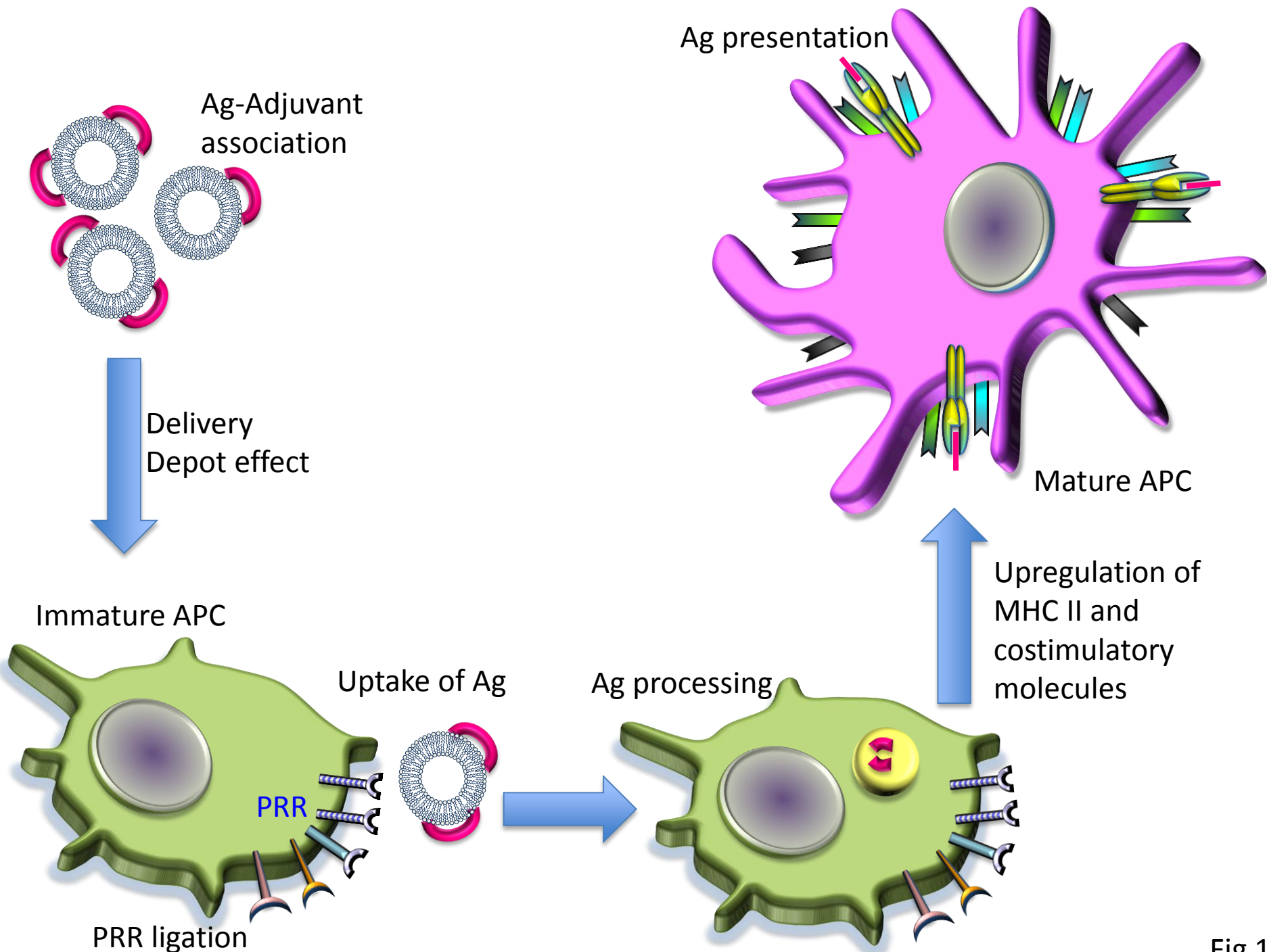

Fig 1

The **rigidity** of the bilayer is influenced by the transition temperature of the lipids used; lipid with long unsaturated tails, form more rigid bilayers and tend to induce stronger immune responses.

The addition of **cholesterol** can improve bilayer stability .  
The addition of **bile salts** can improve oral vaccine stability.

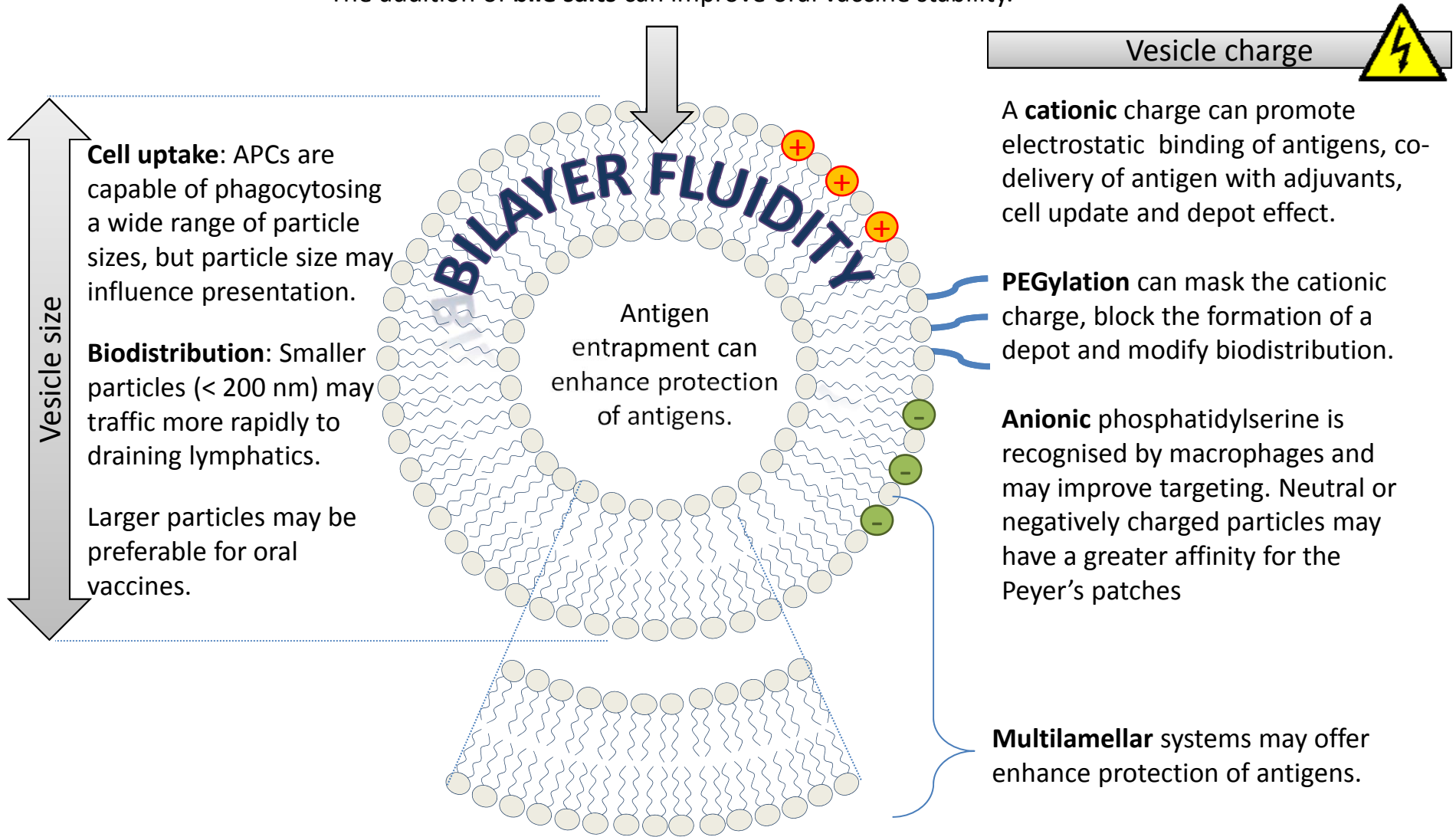

Fig 2

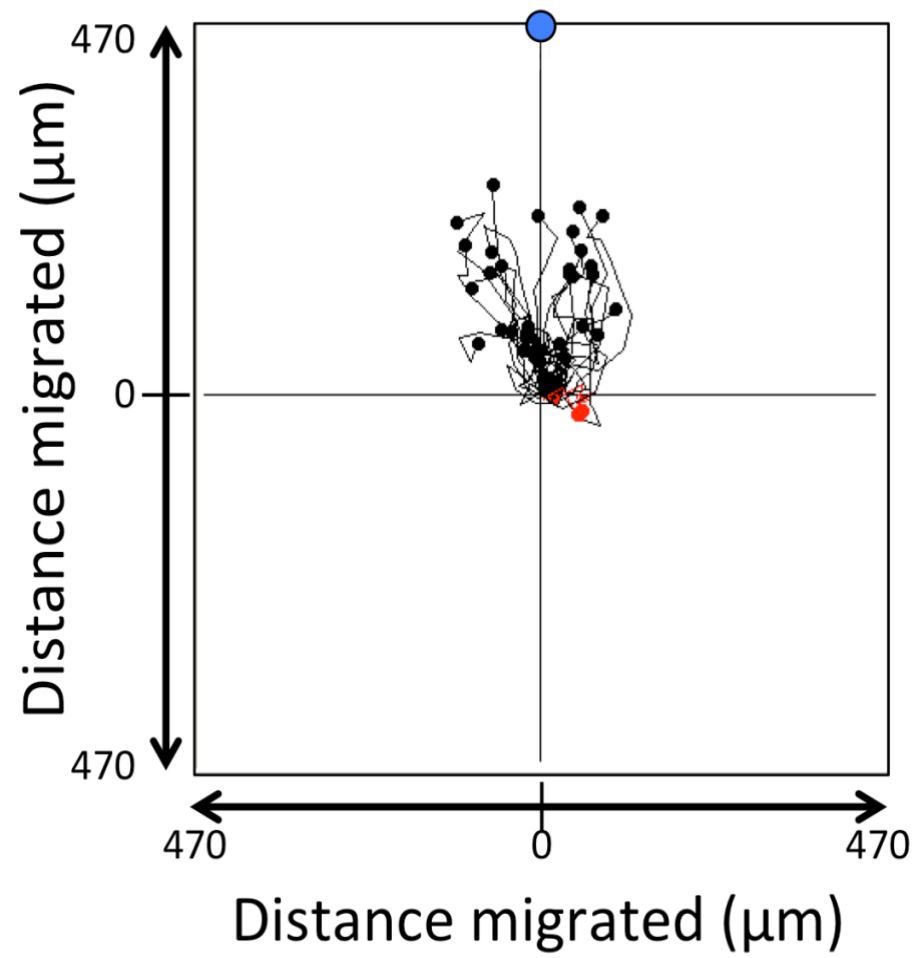

Fig 3

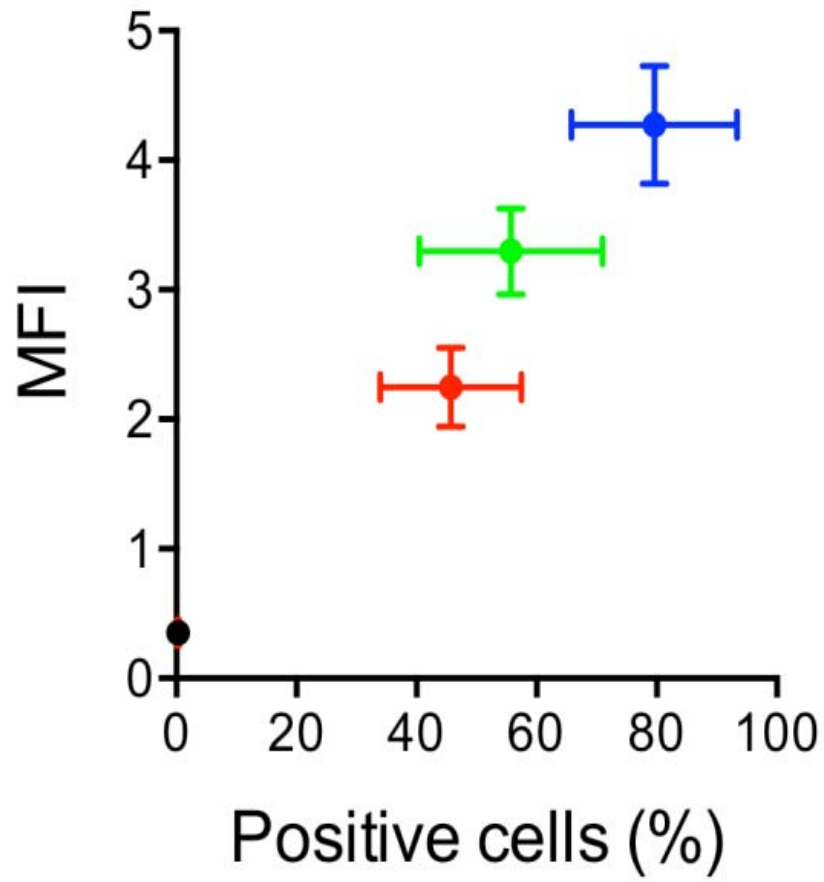

Fig 4

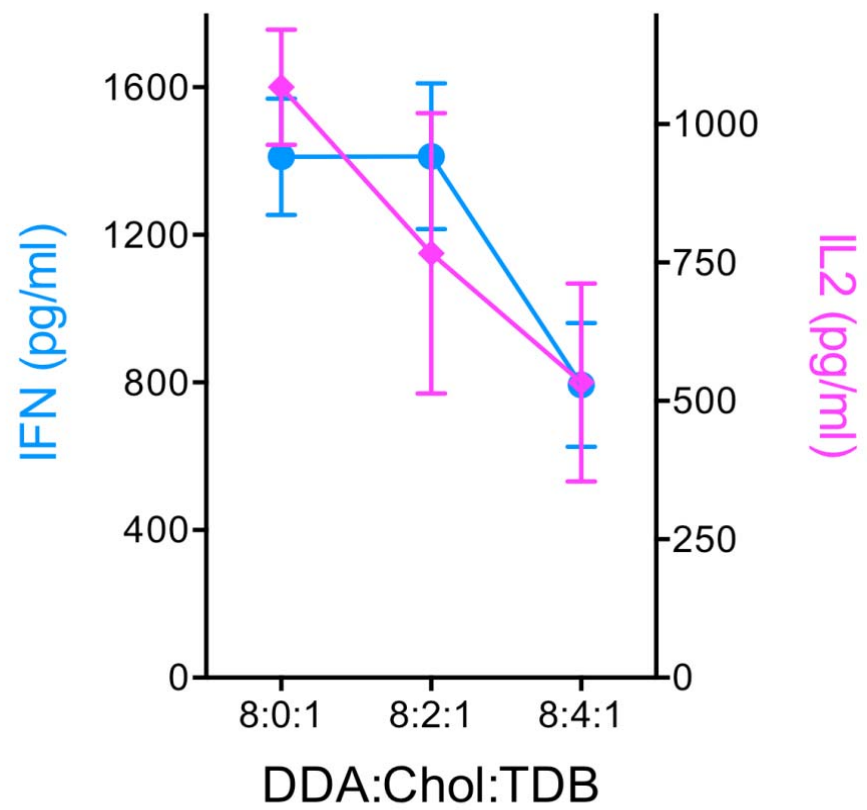
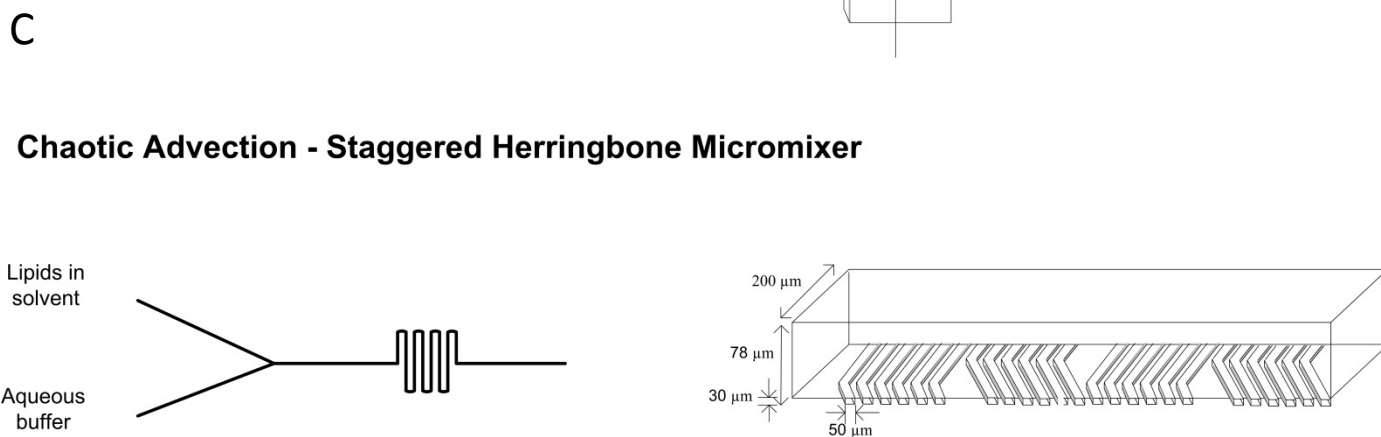
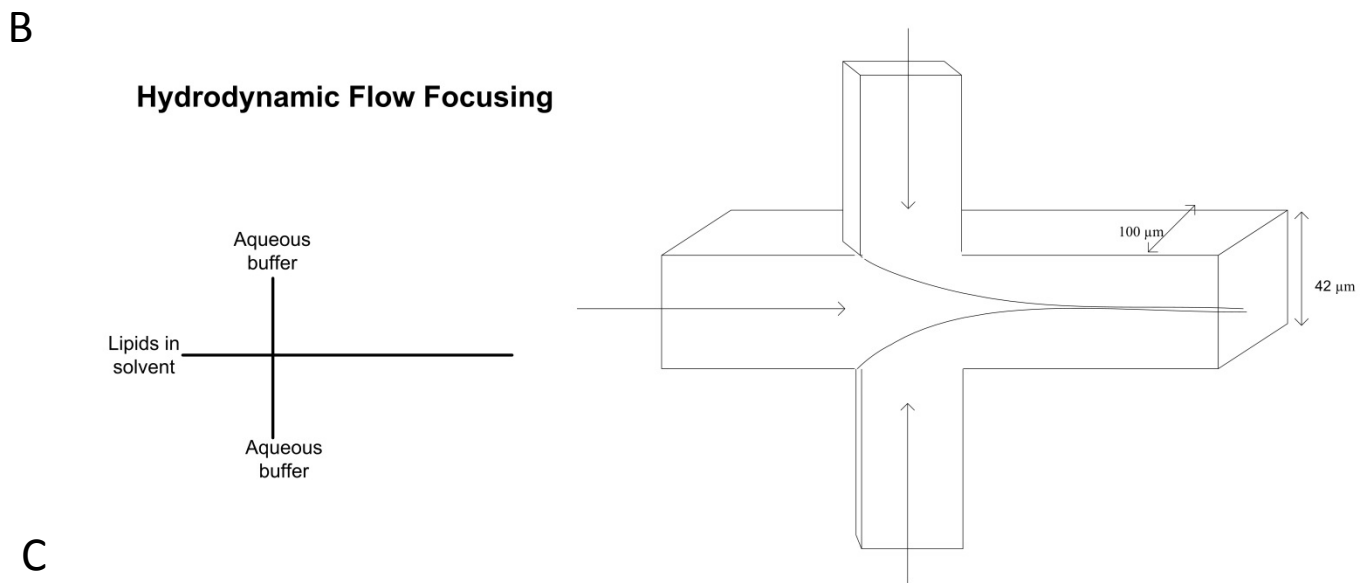
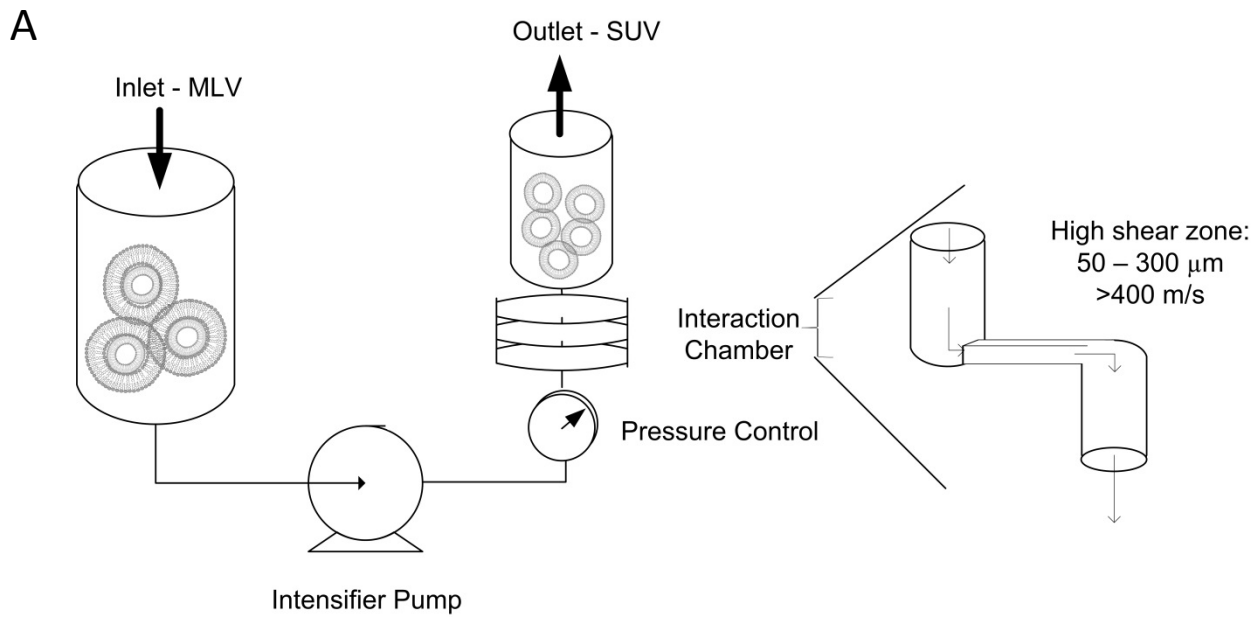

Fig 5



**Fig 6**